



Serrures et paumelles
Locksets and hinges

ASSA ABLOY

Serrures *Locksets*

Lagune

Caractéristiques techniques générales

- Montage sur encoche 64A
- Réversible
- À cylindre européen panneton DIN (norme DIN 18254)
- Rappel du pêne à la clé
- Pour porte en verre trempé de 8 et 10 mm
- Condamnation par clé avec avancement du pêne
- Possibilités de combinaison avec passe général
- Livrée avec gâche plate et 3 clés

General technical features

- To fit notch 64A
- Reversible
- European profile cylinder (DIN standard 18254)
- Return of latch bolt by key
- For toughened glass doors 8-10 mm thick
- Locked by key with forward motion of latch bolt
- Possibility of combinations with master key
- Supplied with flat keep and 3 keys

4300

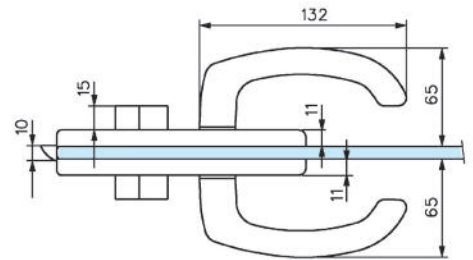
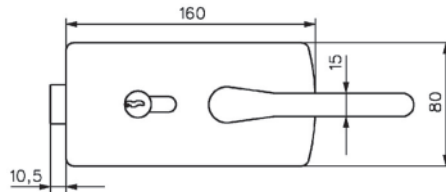
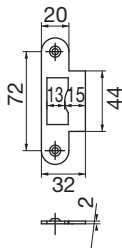
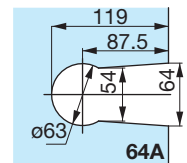

Références / References

Serrure de milieu à cylindre et double béquilles
Lock with euro profile cylinder and pair of handles



Chromé brillant
Bright chromium



Chromé mat
Matt chromium



Doré
Gold plated



Laqué blanc 9010
Lacquered white RAL 9010

4300.30.0

4300.31.0

4300.40.0

4300.51.0



4309.**.0

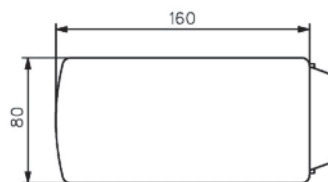
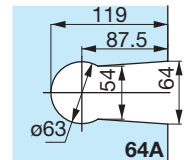

Références / References

Boîtier gâche pour serrures séries 4300
Matching patch keep for locks series 4300-4310-4350



Chromé brillant
Bright chromium



Chromé mat
Matt chromium



Doré
Gold plated



Laqué blanc 9010
Lacquered white RAL 9010

4309.30.0

4309.31.0

4309.40.0

4309.51.0



LES + PRODUITS

The + product

Design

Certifié TUV

Nombreuses
versions

Réversible

Elegant Design

TUV certified

Large variety
of models

Reversible



0309

Gâche équerre pour serrures séries 4300-4310
Keep plate with stop for locks series 4300-4310



Chromé brillant
Bright chromium



Chromé mat
Matt chromium

0309.30.0

0309.31.0

4306

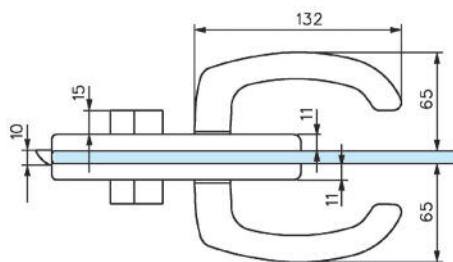
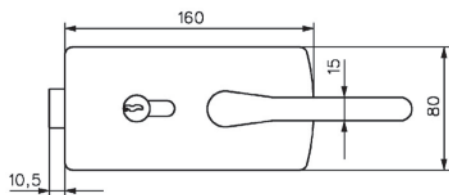
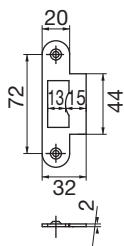
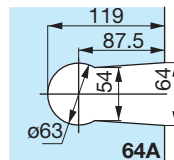

Références / References



Serrure de milieu à cylindre à bécilles condamnation
sans avancement du pêne

Lock with euro profile cylinder and double handles, without
forward motion of latch bolt



Chromé brillant
Bright chromium



Chromé mat
Matt chromium

4306.30.0

4306.31.0

4301

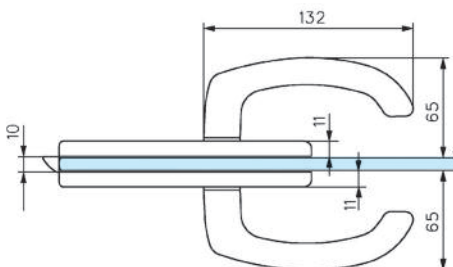
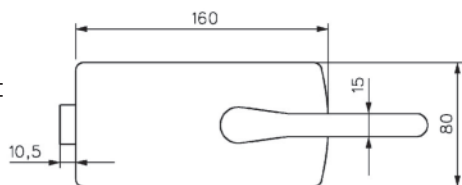
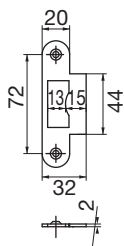
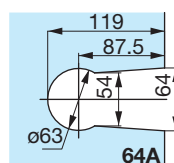

Références / References



Chromé brillant
Bright chromium



Chromé mat
Matt chromium



Doré
Gold plated



Laqué blanc 9010
Lacquered white RAL 9010

Serrure de milieu bec de canne
et double bécilles

Latch set with pair of handles

4301.30.0

4301.31.0

4301.40.0

4301.51.0

4307

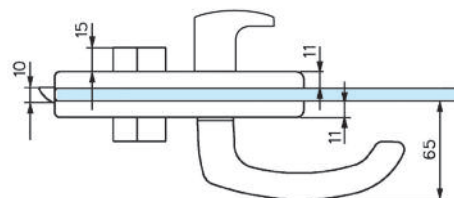
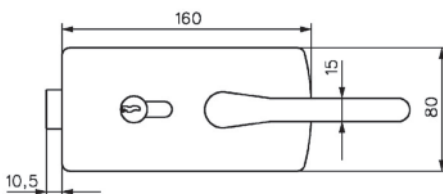
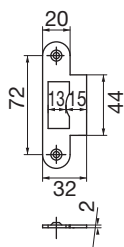
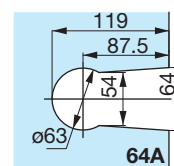

Références / References



Chromé brillant
Bright chromium



Chromé mat
Matt chromium

4307.30.0

4307.31.0

Serrure de milieu à cylindre avec béquille intérieure et bouton fixe extérieur, condamnation sans avancement du pêne

Lock with euro profile cylinder, lever handle inside and fixed knob outside, without forward motion of latch bolt

4310

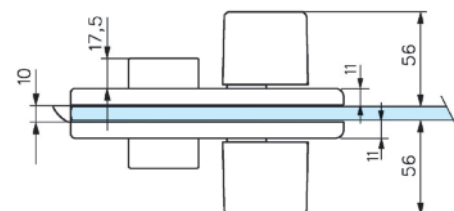
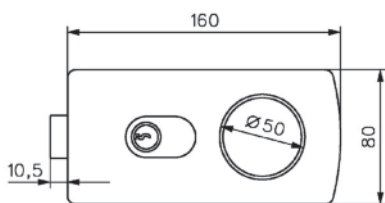
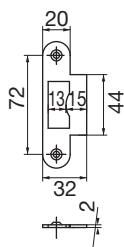
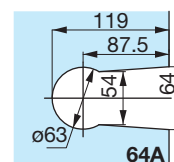

Références / References



Chromé brillant
Bright chromium



Chromé mat
Matt chromium



Doré
Gold plated

4310.30.0

4310.31.0

4310.40.0

Serrure de milieu à cylindre et boutons de manoeuvre avec caches cylindre

Lock with euro profile cylinder and pair of knobs with cylinder covers

4311

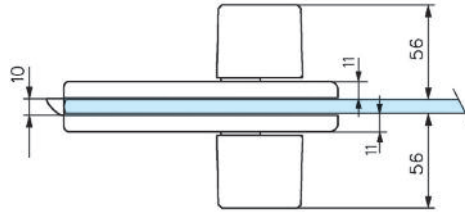
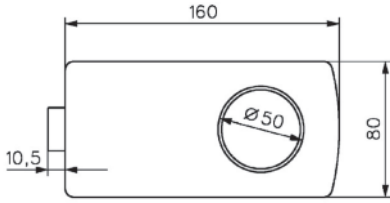
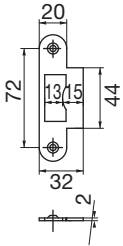
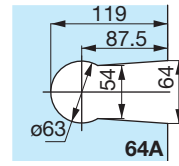

Références / References



Chromé brillant
Bright chromium



Chromé mat
Matt chromium



Doré
Gold plated

Serrure de milieu bec de cane et boutons de manoeuvre
Latch lock with pair of knobs

4311.30.0

4311.31.0

4311.40.0

4312

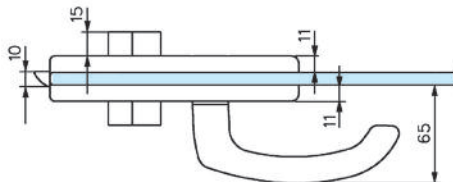
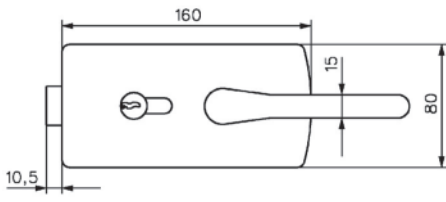
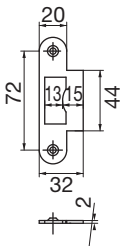
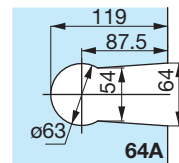

Références / References



Chromé brillant
Bright chromium



Chromé mat
Matt chromium

Serrure de milieu à cylindre avec une seule béquille intérieure
Lock with euro profile cylinder and lever handle inside only

4312.30.0

4312.31.0

4360

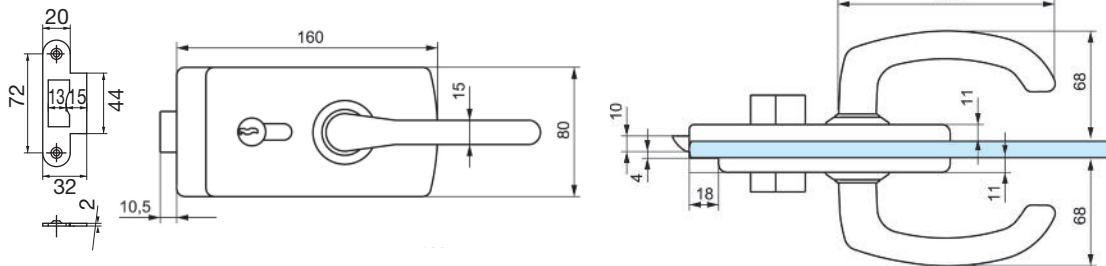
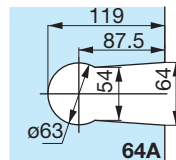

Références / References

Serrure de milieu à cylindre et béquilles avec déport, pêne axé
Lock with euro profile cylinder, handles and offset mechanism



Chromé brillant
Bright chromium



Chromé mat
Matt chromium



Doré
Gold plated



Laqué blanc 9010
Lacquered white RAL 9010



4360.30.0

4360.31.0

4360.40.0

4360.51.0



4360.30.4

4360.31.4

• Le mécanisme déporté permet un contact de la porte en fond de feuillure, et assure la continuité du joint au niveau de la serrure.

• Offset mechanism to allow compression of rebate strip.

4361

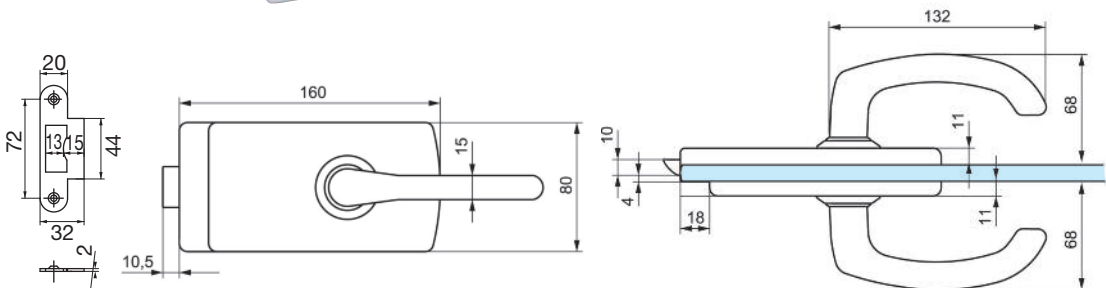
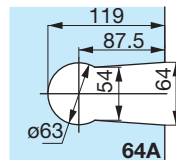

Références / References

Serrure de milieu bec de cane et béquilles avec déport, pêne axé
Latch set with handles and offset mechanism



Chromé brillant
Bright chromium



Chromé mat
Matt chromium



Doré
Gold plated



Laqué blanc 9010
Lacquered white RAL 9010



4361.30.0

4361.31.0

4361.40.0

4361.51.0



4361.30.4

4361.31.4

• Le mécanisme déporté permet un contact de la porte en fond de feuillure, et assure la continuité du joint au niveau de la serrure.

• Offset mechanism to allow compression of rebate strip.

LES + PRODUITS

Mécanisme déporté

Offset mechanism



4360.0BT

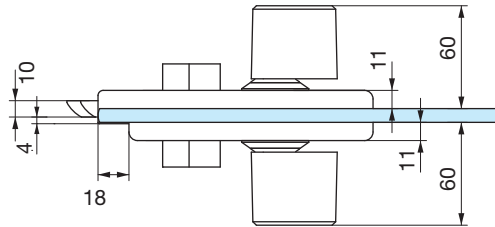
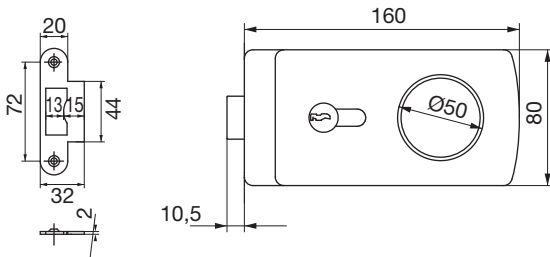
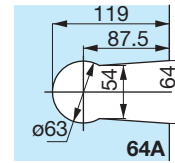

Références / References



Chromé brillant
Bright chromium



Chromé mat
Matt chromium



Laqué blanc 9010
Lacquered white RAL 9010

Serrure de milieu à cylindre et boutons de manoeuvre avec déport, pêne axé
Lock with euro profile cylinder with pair of knobs and offset mechanism

4360.30.0BT

4360.31.0BT

4360.51.0BT

- Le mécanisme déporté permet un contact de la porte en fond de feuillure, et assure la continuité du joint au niveau de la serrure.

- Offset mechanism to allow compression of rebate strip.

4361.0BT

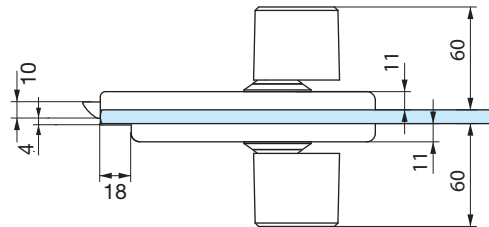
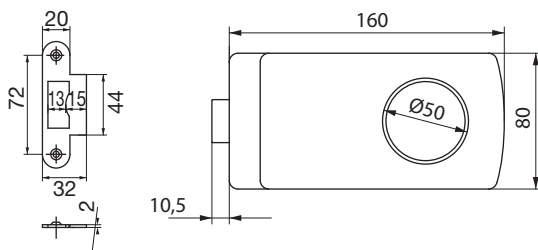
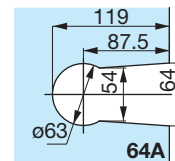

Références / References



Chromé brillant
Bright chromium



Chromé mat
Matt chromium



Laqué blanc 9010
Lacquered white RAL 9010

Serrure de milieu bec de cane avec déport et 2 boutons de manoeuvre
Latch set with knobs and offset mechanism

4361.30.0BT

4361.31.0BT

4361.51.0BT

- Le mécanisme déporté permet un contact de la porte en fond de feuillure, et assure la continuité du joint au niveau de la serrure.

- Offset mechanism to allow compression of rebate strip.

Serrures et paumelles
Locksets and hinges

4363.0E*T

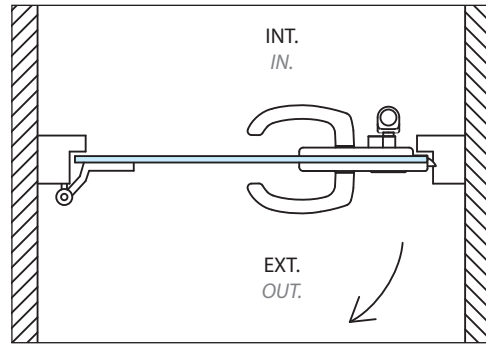
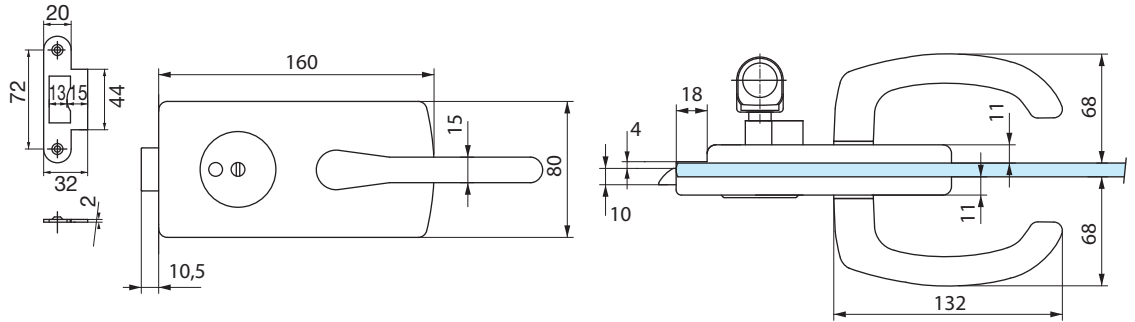
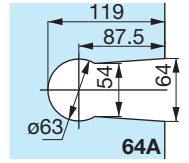

Références / References



Chromé brillant
Bright chromium



Chromé mat
Matt chromium

Serrure avec voyant ouverture extérieure droite tirant
Lock with colour indicator outside opening right pull

4363.30.0EDT 4363.31.0EDT

• Le mécanisme déporté permet un contact de la porte en fond de feuillure, et assure la continuité du joint au niveau de la serrure.

• Offset mechanism to allow compression of rebate strip.

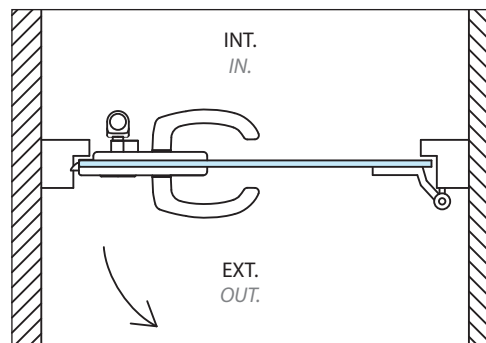

Références / References



Chromé brillant
Bright chromium



Chromé mat
Matt chromium

Serrure avec voyant ouverture extérieure gauche tirant
Lock with colour indicator outside opening left pull

4363.30.0EGT 4363.31.0EGT

• Le mécanisme déporté permet un contact de la porte en fond de feuillure, et assure la continuité du joint au niveau de la serrure.

• Offset mechanism to allow compression of rebate strip.

LES + PRODUITS

Mécanisme déporté

Idéal pour cabine et vestiaire

Sécurité : décondamnation d'urgence

Offset mechanism

Ideal for toilets and cloakrooms

Security : emergency exit

4363.01*P

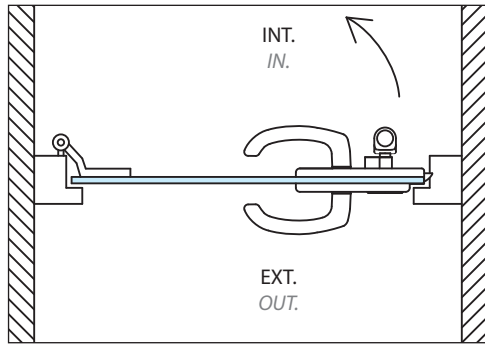
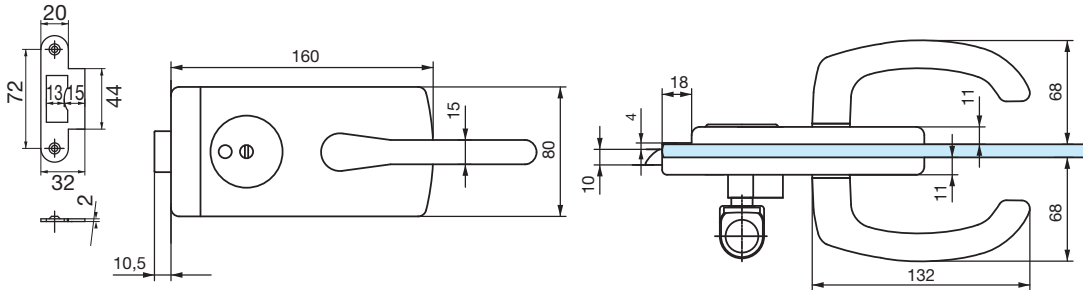
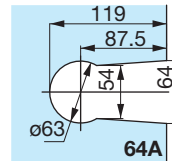

Références / References



Chromé brillant
Bright chromium



Chromé mat
Matt chromium

Serrure avec voyant ouverture intérieure droite poussant
Lock with colour indicator inside opening right push

4363.30.0IDP 4363.31.0IDP

- Le mécanisme déporté permet un contact de la porte en fond de feuillure, et assure la continuité du joint au niveau de la serrure.

- Offset mechanism to allow compression of rebate strip.

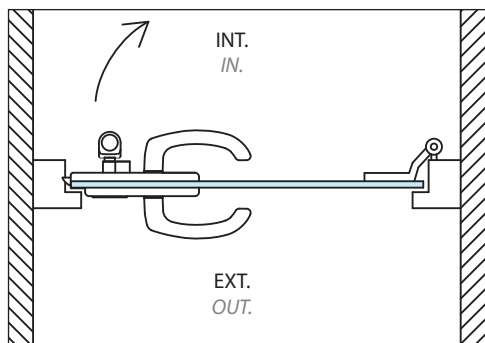

Références / References



Chromé brillant
Bright chromium



Chromé mat
Matt chromium

Serrure avec voyant ouverture intérieure gauche poussant
Lock with colour indicator inside opening left push

4363.30.0IGP 4363.31.0IGP

- Le mécanisme déporté permet un contact de la porte en fond de feuillure, et assure la continuité du joint au niveau de la serrure.

- Offset mechanism to allow compression of rebate strip.

4367.0**

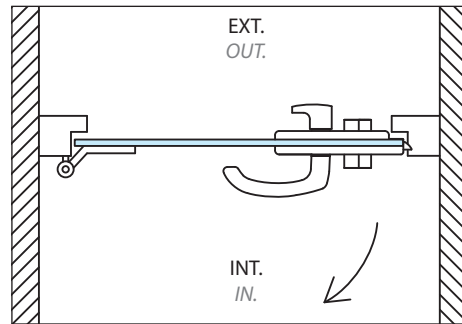
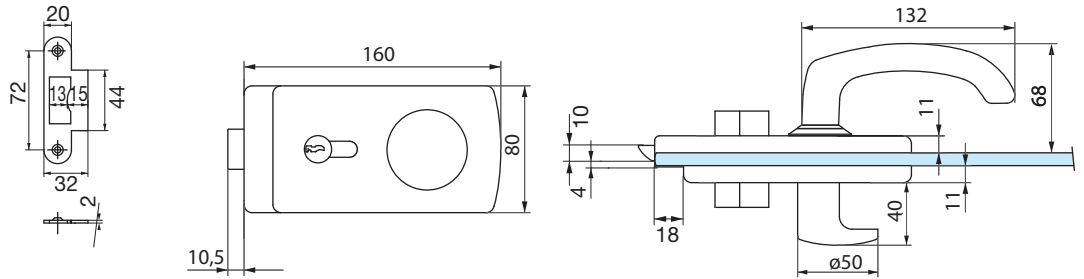
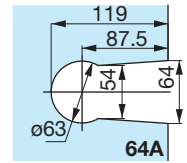

LES + PRODUITS

Mécanisme déporté

Offset mechanism

Références / References



Chromé brillant
Bright chromium



Chromé mat
Matt chromium

Serrure de milieu à cylindre et déport avec béquille intérieure et bouton fixe extérieur, condamnation sans avancement du pêne
Lock with euro profile cylinder and offset with handle inside fixed knob outside, without forward latch bolt motion

4367.30.0AD

4367.31.0AD

- Le mécanisme déporté permet un contact de la porte en fond de feuillure, et assure la continuité du joint au niveau de la serrure.

- Offset mechanism to allow compression of rebate strip.

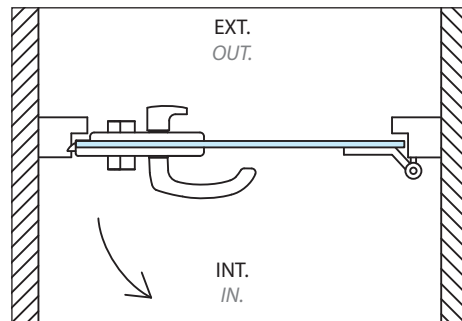

Références / References



Chromé brillant
Bright chromium



Chromé mat
Matt chromium

Serrure de milieu à cylindre et déport avec béquille intérieure et bouton fixe extérieur, condamnation sans avancement du pêne
Lock with euro profile cylinder and offset with handle inside fixed knob outside, without forward latch bolt motion

4367.30.0BC

4367.31.0BC

- Le mécanisme déporté permet un contact de la porte en fond de feuillure, et assure la continuité du joint au niveau de la serrure.

- Offset mechanism to allow compression of rebate strip.

4366

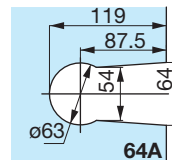

Serrures et
paumelles
Locksets and
hinges

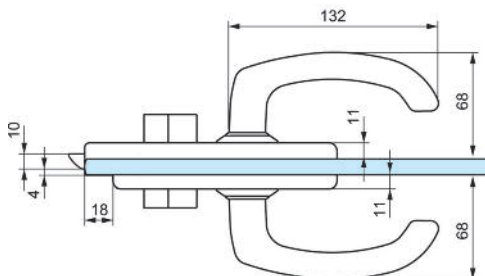
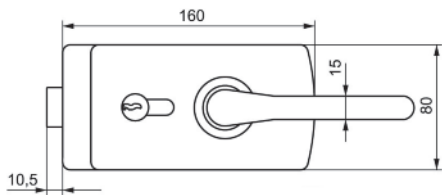
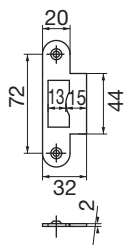

Références / References



Chromé mat
Matt chromium

Serrure de milieu à barillet et béquilles avec déport, condamnation sans avancement de pêne
Lock with euro profile cylinder offset and handles without forward motion of latch bolt

4366.31.0

- Le mécanisme déporté permet un contact de la porte en fond de feuillure, et assure la continuité du joint au niveau de la serrure.
- Offset mechanism to allow compression of rebate strip.



4380

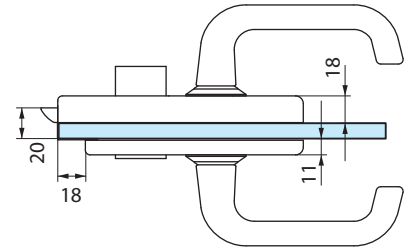
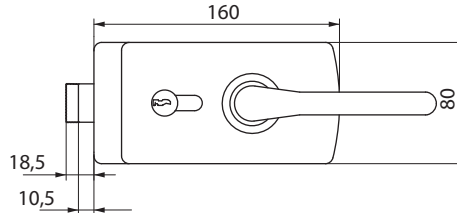
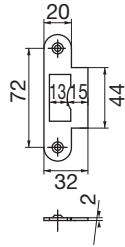
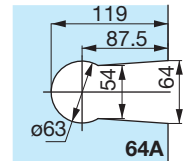

Références / References

Serrure de milieu à cylindre et béquilles avec déport, pêne désaxé, condamnation sans avancement de pêne
Lock set with handles, offset mechanism and spring bolt without forward motion of latch bolt



Chromé brillant
Bright chromium



Chromé mat
Matt chromium



Laqué blanc 9010
Lacquered white RAL 9010



4380.30.0

4380.31.0

4380.51.0



4380.31.4

- Le mécanisme déporté permet un contact de la porte en fond de feuillure, et assure la continuité du joint au niveau de la serrure.

- Offset mechanism to allow compression of rebate strip.

4381

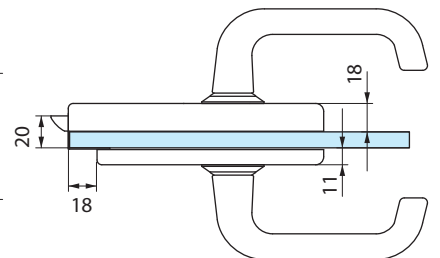
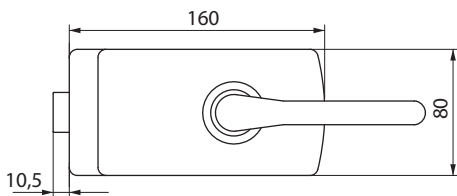
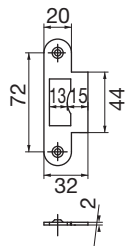
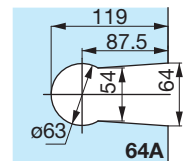

Références / References

Serrure de milieu bec de cane et béquilles avec déport, pêne désaxé,
Latch with with handles, offset mechanism and spring bolt,



Chromé brillant
Bright chromium



Chromé mat
Matt chromium



Laqué blanc 9010
Lacquered white RAL 9010



4381.30.0

4381.31.0

4381.51.0

- Le mécanisme déporté permet un contact de la porte en fond de feuillure, et assure la continuité du joint au niveau de la serrure.

- Offset mechanism to allow compression of rebate strip.

4389

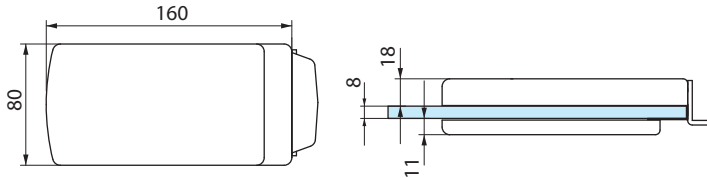
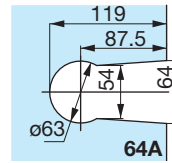

Serrures et
paumelles
Locksets and
hinges

Références / References



Chromé brillant
Bright chromium



Chromé mat
Matt chromium

Boîtier gâche pour serrures série 4380 - 4381
Matching patch keep for locks series 4380 - 4381

4389.30.0

4389.31.0

KITS SERRURE / KIT LOCK



Visuel non contractuel - contenu peut varier
Photo non contractual - contents can differ.

Références / References

Kit complet / Complete Kit



Chromé brillant
Bright chromium



Chromé mat
Matt chromium



Laqué Blanc
Lacquered white



Kit serrure 4300 + 2 paumelles 4200 et 2 fiches 3206
Kit lock 4300 + 2 hinges 4200 and 2 butts 3206

4300.30.0K

4300.31.0K

4300.51.0K



Kit serrure 4301 + 2 paumelles 4200 et 2 fiches 3206
Kit lock 4301 + 2 hinges 4200 and 2 butts 3206

4301.30.0K

4301.31.0K

4301.51.0K



Kit serrure 4360 + 2 paumelles et fiches 4203
Kit lock 4360 + 2 hinges and butts 4203

4360.30.0K

4360.31.0K

4360.51.0K



Kit serrure 4361 + 2 paumelles et fiches 4203
Kit lock 4361 + 2 hinges and butts 4203

4361.30.0K

4361.31.0K

4361.51.0K

Bastille

Caractéristiques techniques

- Pour verre trempé de 8 – 10 et 12 mm
- Montage sur encoche 6300EX
- Réversible
- A cylindre européen panneton DIN (norme DIN 18254)
- Avec caches cylindre
- Rappel du pêne à la clé
- Condamnation avec avancement du pêne
- Possibilités de combinaison avec passe général
- Livrée avec gâche plate et 3 clés

Technical features

- For 8 -10 and 12 mm thick toughened glass
- To fit notch 6300EX
- Reversible
- European profile cylinder (DIN standard 18254)
- With cylinder covers
- Return of the latch bolt by key
- Locked with forward motion of latch bolt
- Possibility of combinations with master key
- Supplied with flat keep and 3 keys

LES + PRODUITS

The + product

Design épuré

Certifié TUV

Grande qualité
de finition

Mécanisme
de précision

Réversible

Refined design

TUV certified

High quality finishes

Precision mechanics

Reversible

- **Le mécanisme déporté permet un contact de la porte en fond de feuillure, et assure la continuité du joint au niveau de la serrure.**

- **Offset mechanism to allow compression of rebate strip.**



4501

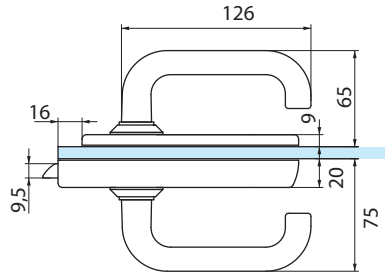
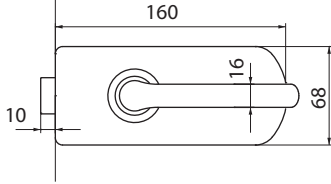
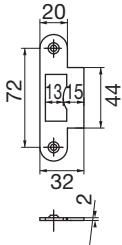
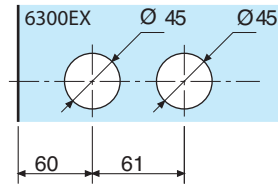

Références / References



Serrure de milieu bec de cane et béquilles
Latch set with pair of handles



Laiton poli PVD
Polished brass PVD

4501.05.0



Chromé brillant
Bright chromium

4501.30.0



Chromé mat
Matt chromium

4501.31.0

4550.**.*

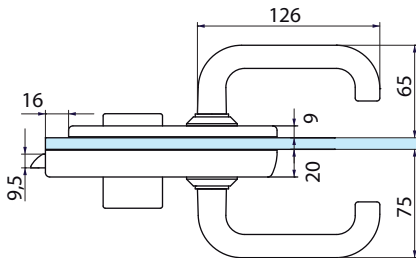
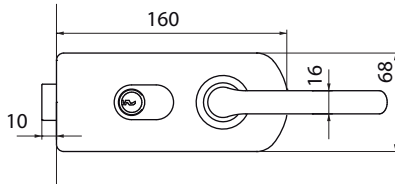
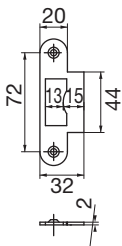
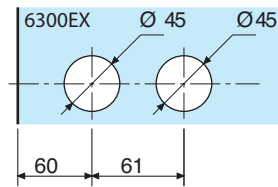

Références / References

Serrure de milieu à cylindre et double béquilles, caches cylindre
Lock with euro profile cylinder, pair of handles and cylinder cover



Laiton poli PVD
Polished brass PVD

4550.05.0



Chromé brillant
Bright chromium

4550.30.0



Chromé mat
Matt chromium

4550.31.0



4550.05.4

4550.30.4

4550.31.4

4550.05.5

4550.30.5

4550.31.5

4555.**.0

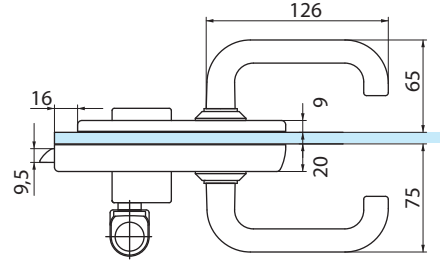
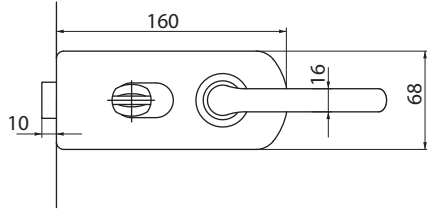
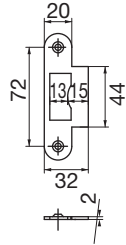
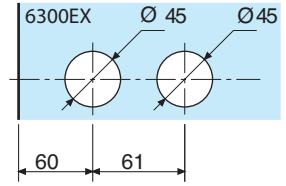

Références / References

Serrure de milieu avec cylindre à bouton et double béquilles, caches cylindre

Lock with thumb turn cylinder, pair of handles and cylinder cover



Laiton poli PVD
Polished brass PVD



Chromé brillant
Bright chromium



Chromé mat
Matt chromium



4555.05.0

4555.30.0

4555.31.0



4555.05.4

4555.30.4

4555.31.4



4555.05.5

4555.30.5

4555.31.5

4509

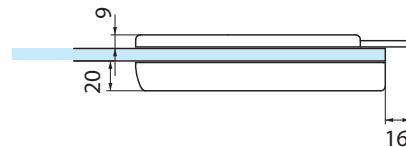
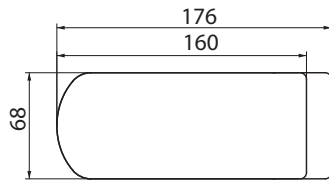
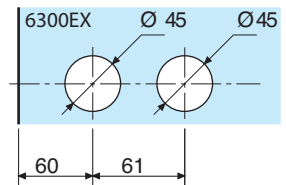

Références / References



Laiton poli PVD
Polished brass PVD



Chromé brillant
Bright chromium



Chromé mat
Matt chromium

Boîtier gâche pour serrures série 4500
Matching patch keep for locks series 4500

4509.05.0

4509.30.0

4509.31.0



Lumira

Caractéristiques techniques

- Pour verre trempé de 8, 10 et 12 mm
- Montage sur encoche 6300EX
- Réversible
- Condamnation par clé avec avancement du pêne
- Rappel du pêne tour à la clé
- Livré avec gâche plate

Technical features

- For 8- 10 and 12 mm thick toughened glass
- To fit notch 6300EX
- Reversible
- Locked by key with forward motion of latch bolt
- Retractable latch bolt by key
- Supplied with flat keep

LES + PRODUITS

The + product

Mécanisme
déporté

Résistance à l'usage
intensif

Nombreuses
versions

Offset mechanism

Resistance
to heavy use

Large variety
of models

V525

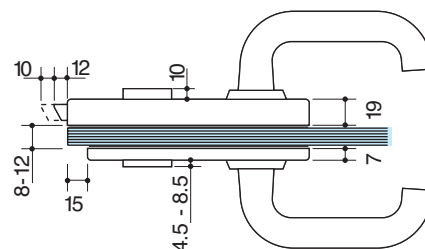
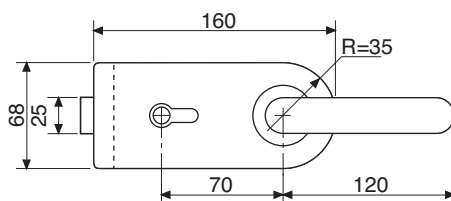
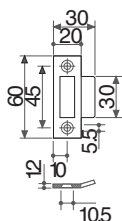
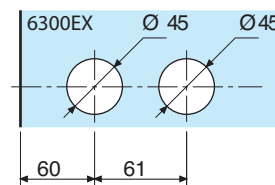

Références / References



Serrure de milieu avec cylindre Européen
avec béquilles
Lock with euro profile cylinder and handles

Aluminium anodisé Argent Brossé
Brushed anodised alu silver

V525.12

- Le mécanisme déporté permet un contact de la porte en fond de feuillure, et assure la continuité du joint au niveau de la serrure.

- Offset mechanism to allow compression of rebate strip.

V526

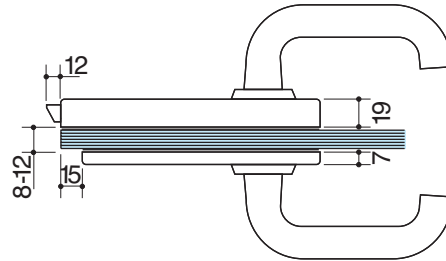
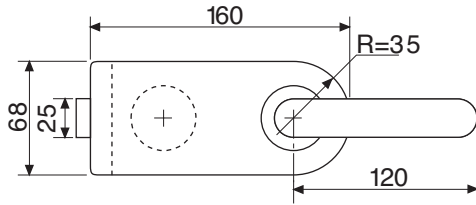
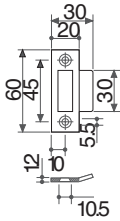
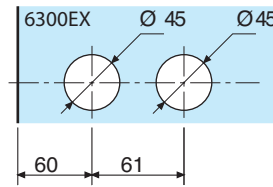

Serrures et
paumelles
Locksets and
hinges

Références / References



Serrure de milieu avec béquille
Latch set with handles

Aluminium anodisé Argent Brossé
Brushed anodised alu silver

V526.12

- Le mécanisme déporté permet un contact de la porte en fond de feuillure, et assure la continuité du joint au niveau de la serrure.

- Offset mechanism to allow compression of rebate strip.

V350

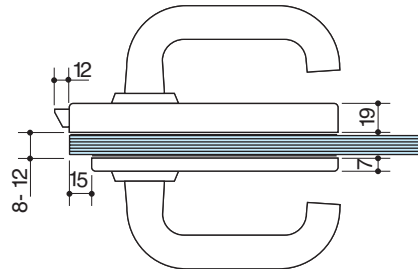
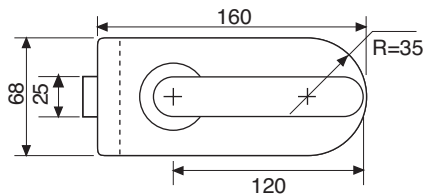
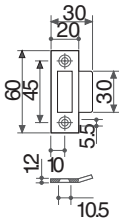
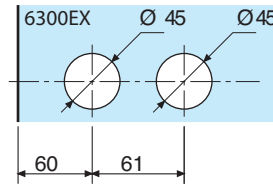

Références / References



Serrure de milieu avec béquilles
Latch set with handles

Aluminium anodisé Argent Brossé
Brushed anodised alu silver

V350.12

- Le mécanisme déporté permet un contact de la porte en fond de feuillure, et assure la continuité du joint au niveau de la serrure.

- Offset mechanism to allow compression of rebate strip.

V310

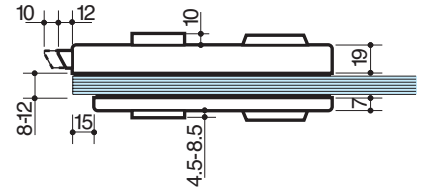
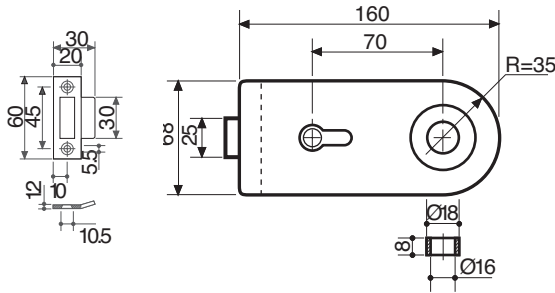
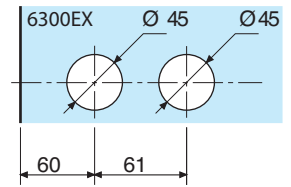

Références / References



Serrure de milieu sans cylindre et pour bouton ou double béquilles
Lock without cylinder and pair of handles or knobs



Aluminium anodisé Argent Brossé
Brushed anodised alu silver



Inox Brossé
Brushed stainless steel



Aluminium anodisé Aninox
Brushed anodised alu.

V310.12

V310.15

V310.36

- Le mécanisme déporté permet un contact de la porte en fond de feuillure, et assure la continuité du joint au niveau de la serrure.

- Offset mechanism to allow compression of rebate strip.

V330

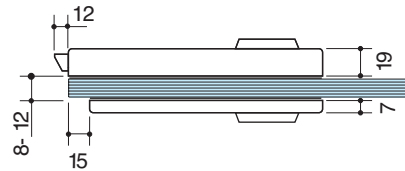
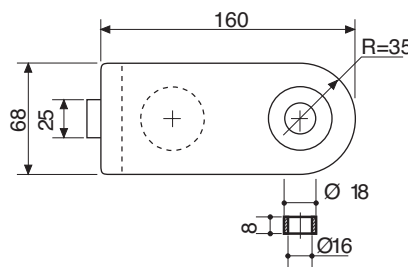
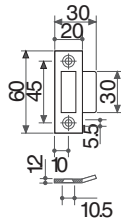
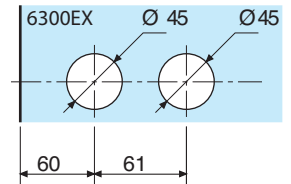

Références / References



Serrure de milieu sans béquille
Latch set without handles



Aluminium anodisé Argent Brossé
Brushed anodised alu silver



Inox Brossé
Brushed stainless steel



Aluminium anodisé Aninox
Brushed anodised alu.

V330.12

V330.15

V330.36

- Le mécanisme déporté permet un contact de la porte en fond de feuillure, et assure la continuité du joint au niveau de la serrure.

- Offset mechanism to allow compression of rebate strip.

V340

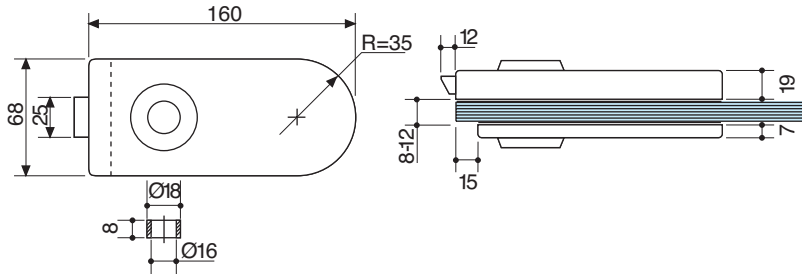
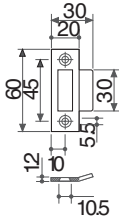
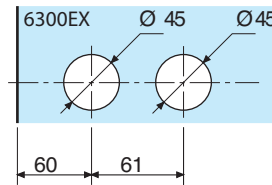

Références / References



Serrure de milieu sans béquille
Latch set without handles



Aluminium anodisé Argent Brossé
Brushed anodised alu silver



Inox Brossé
Brushed stainless steel



Aluminium anodisé Aninox
Brushed anodised alu.

V340.12

V340.15

V340.36

- Le mécanisme déporté permet un contact de la porte en fond de feuillure, et assure la continuité du joint au niveau de la serrure.

- Offset mechanism to allow compression of rebate strip.

V527

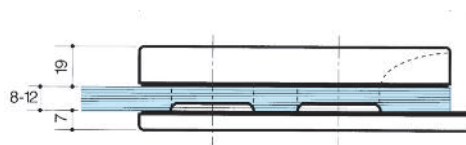
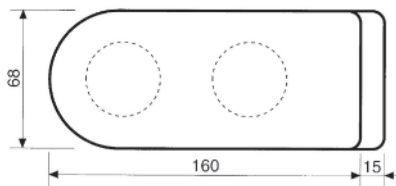
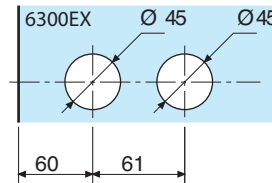

Références / References



Boîtier Gâche pour serrure de milieu série Lumira horizontale.
Matching patch keep for lock series Lumira horizontal



Aluminium anodisé Argent Brossé
Brushed anodised alu silver



Inox Brossé
Brushed stainless steel



Aluminium anodisé Aninox
Brushed anodised alu.

V527.12

V527.15

V527.36

V750

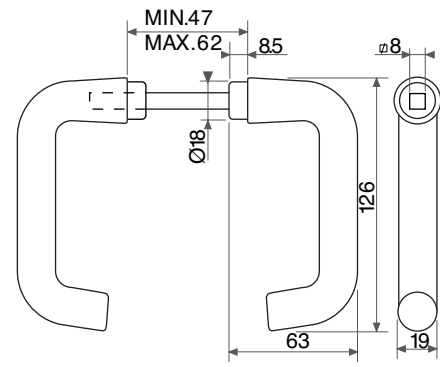

Aluminium anodisé Argent Brossé
Brushed anodised alu silver

Inox Brossé
Brushed stainless steel

V750.12

V750.15

Références / References

Paire de béquilles forme ronde
pour V310, V320, V330 et V340
Pair of lever handles rounded design
for V310, V320, V330 and V340



V525.5.**

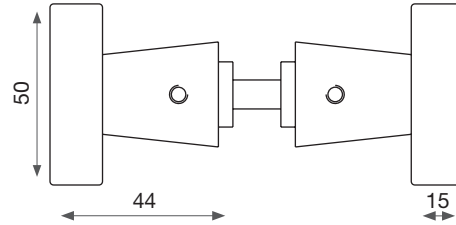

Aluminium anodisé Argent Brossé
Brushed anodised alu silver

V525.5.12

Références / References

Paire de boutons pour V310, V320, V330 et V340
Pair of door knobs for V310, V320, V330 and V340

V554.2

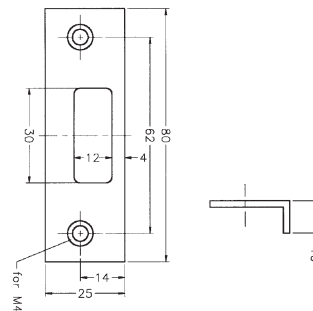

Inox Brossé
Brushed stainless steel

V554.2.15

Références / References

Gâche pour V310, V320, V330 et V340 type allemand
Keep plate for V310, V320, V330 and V340 german style

4391.00.0

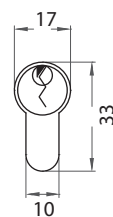
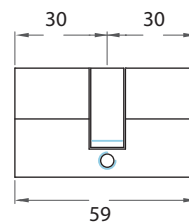
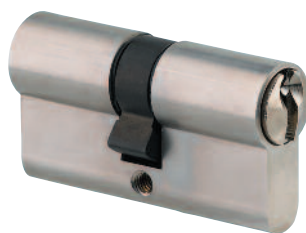

Références / References



Cylindre Européen 30/30 mm
Europrofile cylinder 30/30 mm

4391.00.0

V533.1

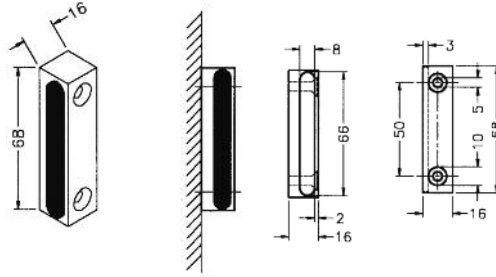

Laiton poli verni
Polished varnished brass



Aluminium anodisé Argent Brossé
Brushed anodised alu silver



Chromé brillant
Bright chromium



Chromé mat brossé
Brushed matt chromium



Aluminium anodisé Aninox
Brushed anodised alu.

Références / References

Butée pour serrure de milieu
Wall stop for locks

V533.1.01

V533.1.12

V533.1.30

V533.1.33

V533.1.36

Serrures et
paumelles
Locksets and
hinges

KITS SERRURE / KIT LOCK



Visuel non contractuel - contenu peut varier
Photo non contractual - contents can differ.



Références / References

Kit complet / Complete Kit



Aluminium anodisé Argent Brossé
Brushed anodised alu silver



Aluminium anodisé Aninox
Brushed anodised alu.

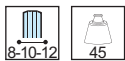

Kit serrure V525 + 2 paumelles V505.2 et 2 caches fiches 4205
Kit lock V525 + 2 hinges V505.2 and 2 covers for butt 4205

V310.12K

V320.36K

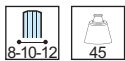

Kit serrure V526 + 2 paumelles V505.2 et 2 caches fiches 4205
Kit lock V526 + 2 hinges V505.2 and 2 covers for butt 4205

V330.12K

V330.36K

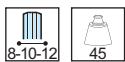

Kit serrure V350 + 2 paumelles V505.2 et 2 caches fiches 4205
Kit lock V350 + 2 hinges V505.2 and 2 covers for butt 4205

V340.12K

V340.36K

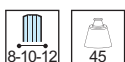

Kit contre boîtier V527 + 2 paumelles V505.2 et 2 caches fiches 4205
Kit matching patch keep V527 + 2 hinges V505.2 and 2 covers for butt 4205

V527.12K

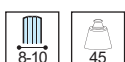

Kit serrure V525 + 2 paumelles V505
Kit lock V525 + 2 hinges V505

V310.12KB

V310.36KB



Kit serrure V526 + 2 paumelles V505
Kit lock V526 + 2 hinges V505

V330.12KB



Kit serrure V350 + 2 paumelles V505
Kit lock V350 + 2 hinges V505

V340.12KB

V340.36KB



Kit contre boîtier V527 + 2 paumelles V505
Kit matching patch keep V527 + 2 hinges V505

V527.12KB

Vertis

Caractéristiques techniques

- Pour verre trempé de 8, 10 et 12 mm
- Montage sur encoche V370E
- Avec pêne demi tour et pêne dormant

Technical features

- For 8-10 and 12 mm thick toughened glass
- To fit notch V370E
- With spring and dead bolt

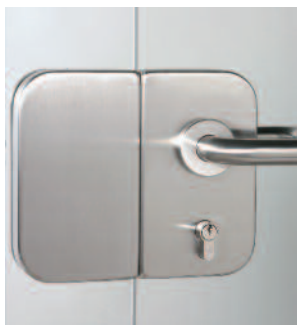

LES + PRODUITS

The + product

Grande qualité de finition

Résistance à l'usage intensif

Sécurité accrue

High quality finishes

Resistance to heavy use

Increased security



V360

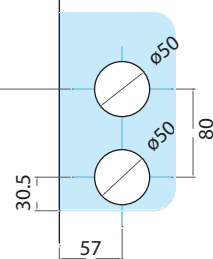
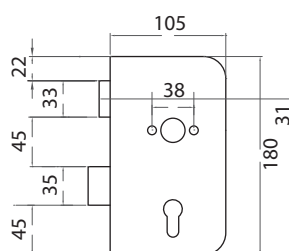
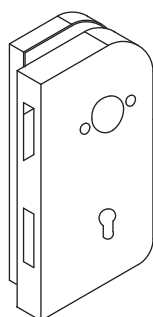

8-10-12

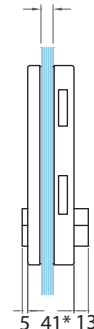

Références / References



Serrure de milieu pour cylindre Européen sans béquille, DIN droite
Lock for Euro profile cylinder without handles DIN right

*=10mm
Aluminium anodisé Argent Brossé
Brushed anodised alu silver

V360.12

Inox Brossé
Brushed stainless steel

V360.15

V370

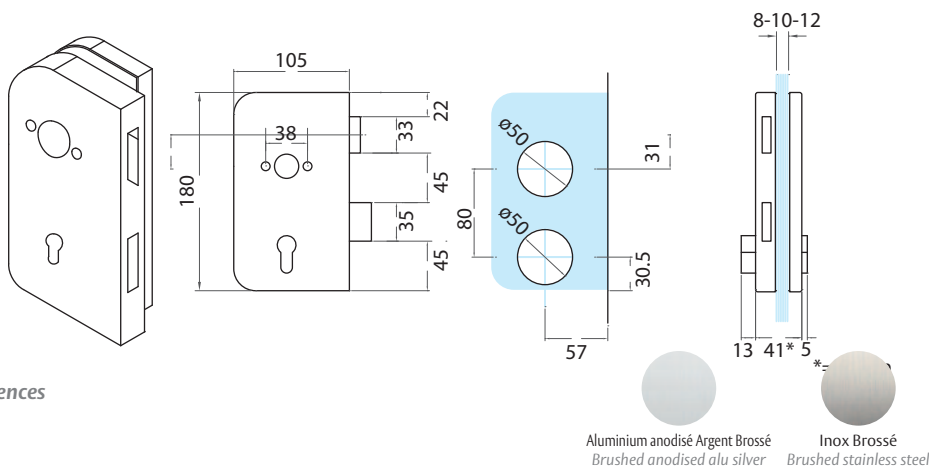

Serrures et paumelles
Locksets and hinges

Références / References



Serrure de milieu pour cylindre Européen sans béquille, DIN gauche
Lock for Euro profile cylinder without handles DIN left

Aluminium anodisé Argent Brossé / Brushed anodised alu silver
Inox Brossé / Brushed stainless steel

V370.12 V370.15

V367

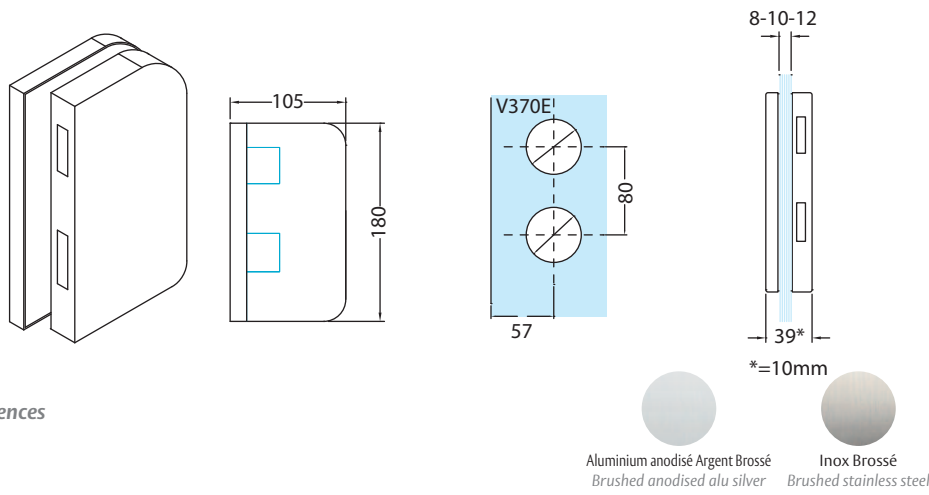

Références / References



Boîtier gâche pour serrure de milieu pour V370 / DIN droite
Matching patch keep for lock V370 / DIN right

Aluminium anodisé Argent Brossé / Brushed anodised alu silver
Inox Brossé / Brushed stainless steel

V367.12 V367.15

V377

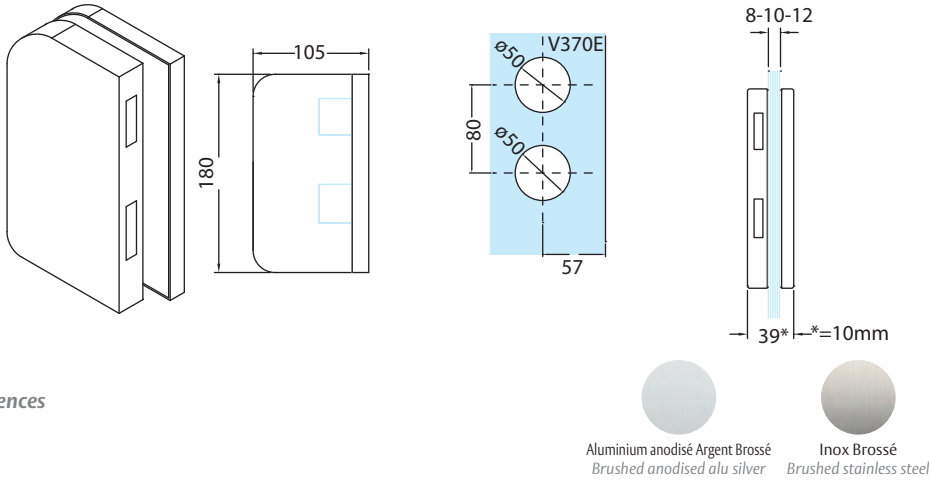

Références / References



Boîtier gâche pour serrure de milieu pour V360 / DIN gauche
Matching patch keep for centre lock V360 / DIN left

Aluminium anodisé Argent Brossé / Brushed anodised alu silver
Inox Brossé / Brushed stainless steel

V377.12 V377.15

Serrures et
paumelles
*Locksets and
hinges*

Vertis SQ

Caractéristiques techniques

- Pour verre trempé de 8, 10 et 12 mm
- Montage sur encoche V370E
- Avec pêne demi tour et pêne dormant

Technical features

- For 8-10 and 12 mm thick toughened glass
- To fit notch V370E
- With spring and dead bolt



LES + PRODUITS

The + product

Grande qualité
de finition

Résistance à l'usage
intensif

Sécurité accrue

High quality finishes

*Resistance
to heavy use*

Increased security



V360SQ

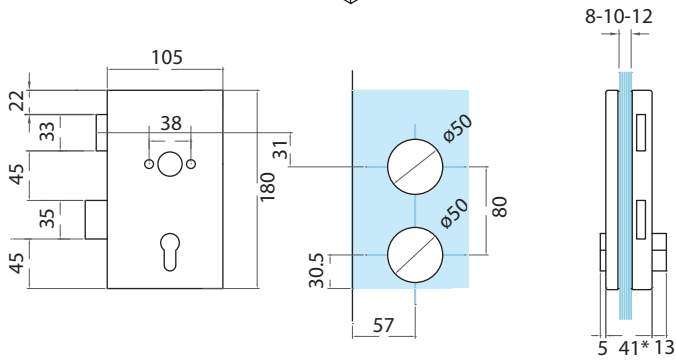
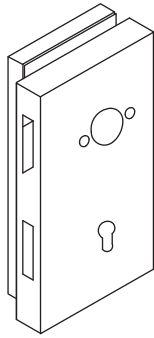

*=10mm



Inox Brossé
Brushed stainless steel

Références / References



Serrure de milieu pour cylindre Européen sans béquille, DIN droite
Lock for Euro profile cylinder without handles DIN right

V360SQ.15

V370SQ

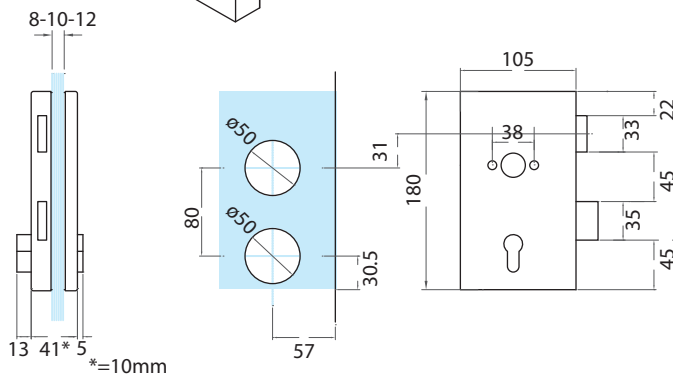
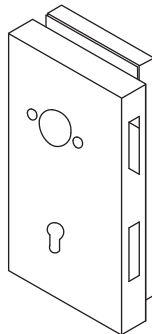

*=10mm



Inox Brossé
Brushed stainless steel

Références / References



Serrure de milieu pour cylindre Européen sans béquille, DIN gauche
Lock for Euro profile cylinder without handles DIN left

V370SQ.15

V770

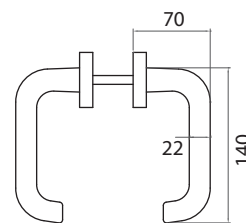

Aluminium anodisé Argent Brossé
Brushed anodised alu silver



Inox Brossé
Brushed stainless steel

Références / References

Paire de béquilles avec rosace pour V360, V370, V360SQ et V370SQ
Pair of lever handles with rosettes for V360, V370, V360SQ et V370SQ

V770.12

V770.15



V780

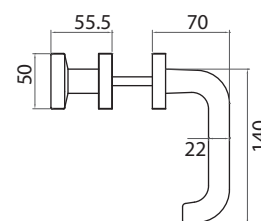

Aluminium anodisé Argent Brossé
Brushed anodised alu silver



Inox Brossé
Brushed stainless steel

Références / References

Bouton fixe / béquille pour V360, V370, V360SQ et V370SQ
Combination fixed knob / lever handle for V360, V370, V360SQ et V370SQ

V780.12

V780.15

V2140

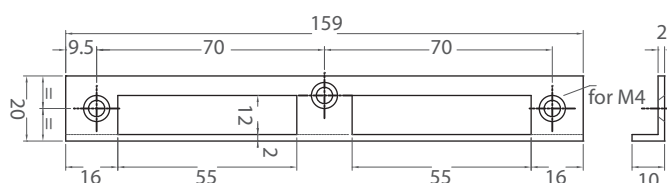

Inox Brossé
Brushed stainless steel

Références / References

Gâche forme L pour V360, V370
Keep plate L shape for V360, V370

V2140.15

V2140.2

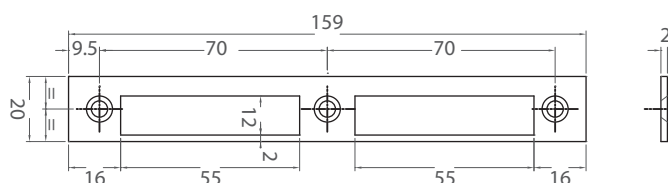

Inox Brossé
Brushed stainless steel

Références / References

Gâche pour V360, V370
Keep plate for V360, V370

V2140.2.15

4391.00.0

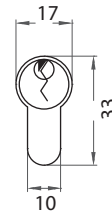
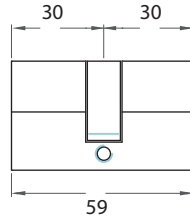
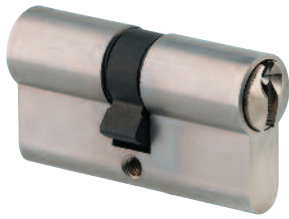

Serrures et
paumelles
Locksets and
hinges

Références / References

Cylindre Européen 30/30 mm
Europrofile cylinder 30/30 mm

4391.00.0

V533.1

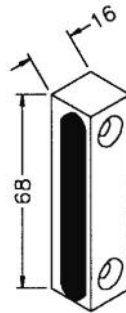

Laiton poli verni
Polished varnished brass



Aluminium anodisé Argent Brossé
Brushed anodised alu silver



Chromé brillant
Bright chromium



Chromé mat brossé
Brushed matt chromium



Aluminium anodisé Aninox
Brushed anodised alu.

Références / References

Butée pour serrure de milieu
Wall stop for lock

V533.1.01

V533.1.12

V533.1.30

V533.1.33

V533.1.36

2881.15.0



Inox Brossé
Brushed stainless steel

Références / References

Butée de porte Ø 35 mm hauteur 40 mm
Door stop 35 Ø X 40 mm height

2881.15.0

Serrures et
paumelles
*Locksets and
hinges*

Classic



Caractéristiques techniques

- Pour verre trempé de 8, 10 mm
- Montage sur encoche 64A avec cale d'encoche et sur les anciennes encoches 60A, 60B, 64
- Réversible par retournement du pêne demi-tour pour adaptation selon sens d'ouverture de la porte
- Pêne demi tour et pêne dormant indépendants
- A cylindres avec protection par bagues tournantes
- Rappel du demi-tour à la clé
- Livré avec gâche plate, 3 clés et cale d'encoche

Technical features

- For 8 and 10 mm thick toughened glass
- To fit notch 64A with notch wedge supplied and on notches 60A, 60B and 64
- Reversible by altering latch bolt to adapt to the opening direction of the door
- Individual latch and dead bolt
- Protected cylinder
- Return of latch bolt with moring collar
- Supplied with flat keep, 3 keys and notch wedge

LES + PRODUITS

The + product

Grande qualité
de finition

Compatible
anciennes encoches

Sécurité :
pêne dormant
indépendant

High quality finishes

*Compatible with long
standing notches*

*Security :
independant bolt*



1300

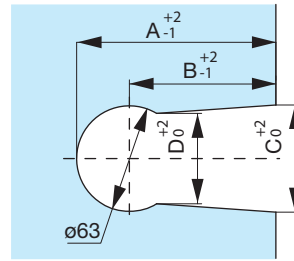

Encoche	A	B	C	D
60A	94,5	62	62	51
60B	94,5	63	65	57
64	110	78,5	65	54
64A	119	87,5	64	54

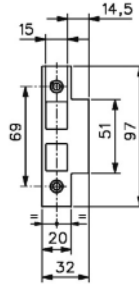
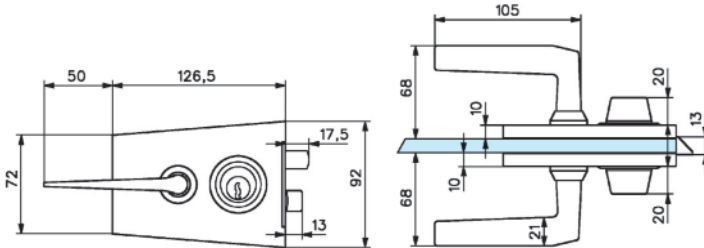

Références / References



Serrure de milieu à cylindre et double béquilles
Lock with cylinder and double handles



Chromé brillant
Bright chromium



Chromé mat
Matt chromium

1300.30.0

1300.31.0

1309

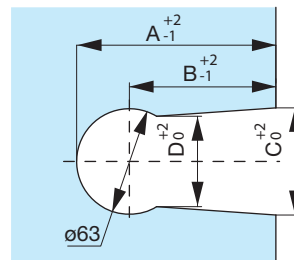

Encoche	A	B	C	D
60A	94,5	62	62	51
60B	94,5	63	65	57
64	110	78,5	65	54
64A	119	87,5	64	54

Références / References



Boîtier gâche pour serrures série 1300
Matching patch keep for locks series 1300



Chromé brillant
Bright chromium



Chromé mat
Matt chromium

1309.30.0

1309.31.0

Open Glass

Caractéristiques techniques

- Kit de transformation d'une porte en bois par une porte en verre.
- Pour verre trempé de 8 mm
- Hauteur maxi dans la feuillure 2200 mm
- Largeur maxi dans la feuillure 1000 mm
- Pour des feuillures de 35 à 48 mm de profondeur

Technical features

- Kit for transformation of wooden door to glass door
- Pour verre trempé de 8 mm
- Maximum height in the frame 2200 mm
- Maximum width in the frame 1000 mm
- For frames of 35 to 48 mm in depth

LES + PRODUITS

Design
Confort
Simplicité
et rapidité de pose

Design
User comfort
Quick and easy
assembling

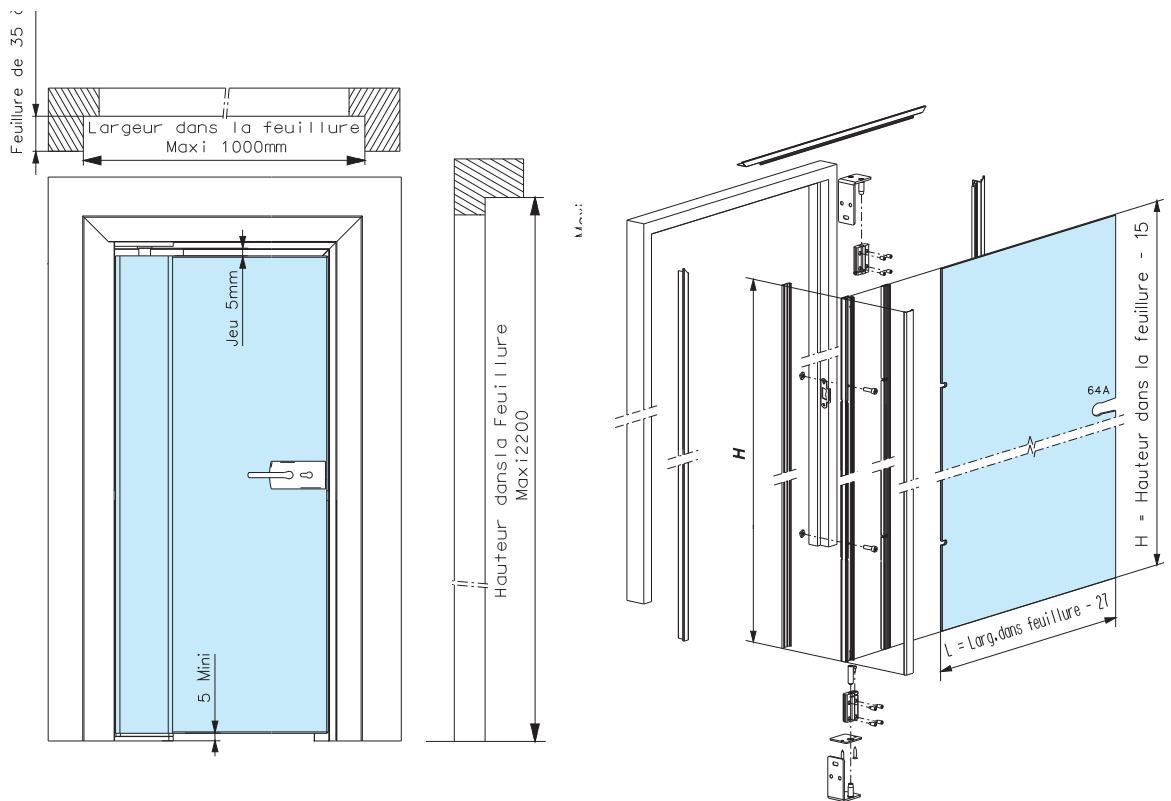

Références / References



Aluminium anodisé Argent Brossé
Brushed anodised alu silver

Laqué blanc 9010
Lacquered white RAL 9010

Kit rénovation pour porte intérieure
Renovation kit for interior door

KPR01/08.12

KPR01/08.51

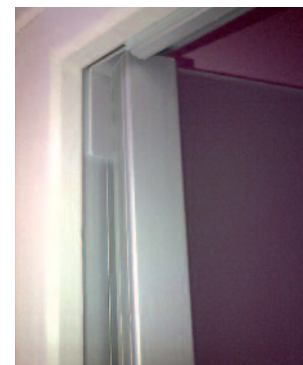

Ce kit comprend

- 2 Profils verticaux lg 2200 mm et 1 profil horizontal lg 1000 mm pour l'habillage du bâtis.
- 5 mètres de joint périphérique
- 1 Profil articulé avec capots et pivots Haut et Bas intégrés
- Livré avec vis de fixation et gâche plate spécifique pour serrure réf : 4360.**.0 et 4361.**.0

This kit includes

- 2 vertical profiles 2200 mm in length and 1 horizontal profile 1000 mm in length for the casing
- 5 metres of seal for frame
- 1 hinged profile with top and bottom integrated pivots and cover
- Delivered with fixing screws and flat strike plate compatible with the lock ref 4360.**.0 and 4361.**.0

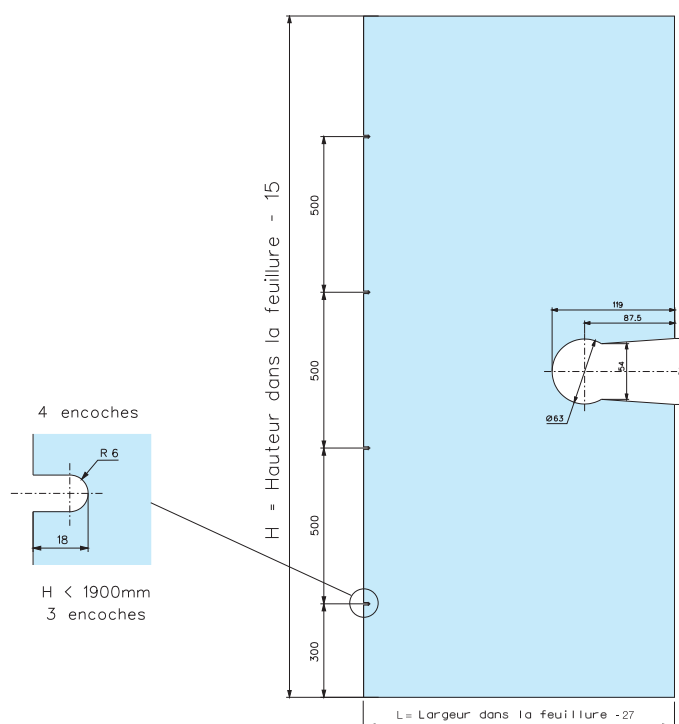

Doorframe

Caractéristiques techniques

- Pour porte en verre trempé de 8, 10 et 12 mm
- Pour panneaux fixe de 8, 10, 12 et 15 mm
- Profil permettant d'appliquer différentes charnières
- Compatible avec les serrures séries LUMIRA, LUMIRA vertical, BASTILLE, LAGUNE
- Le galet de blocage RS02 peut être installé avec une paire de poignées ou une paire de boutons
- Possibilité d'intégration d'une gâche électrique (voir chapitre contrôle d'accès)
- Permet l'intégration facile d'une porte en verre dans un ensemble Sécurité
- Utilisation des profils KL001 et KL002 recommandé pour fixation de l'ensemble

Technical features

- For doors of 8, 10 and 12 mm. thick toughened glass
- For fixed panels of 8, 10, 12 and 15 mm
- Profile allowing several different hinges
- Compatible with lock series LUMIRA, LUMIRA vertical, BASTILLE, LAGUNE
- A blocking roller keep can be installed so handles or door knobs can be used
- Possible installation of an electric release keep (see chapter access control)
- Allows an easy integration of a glass door in a Securit set
- Use KL001 and KL002 profiles recommended to fix the frames

LES + PRODUITS

The + product

Esthétique

Étanchéité
acoustique

Installation facile

Elegant design

Sound proofed

Easy installation

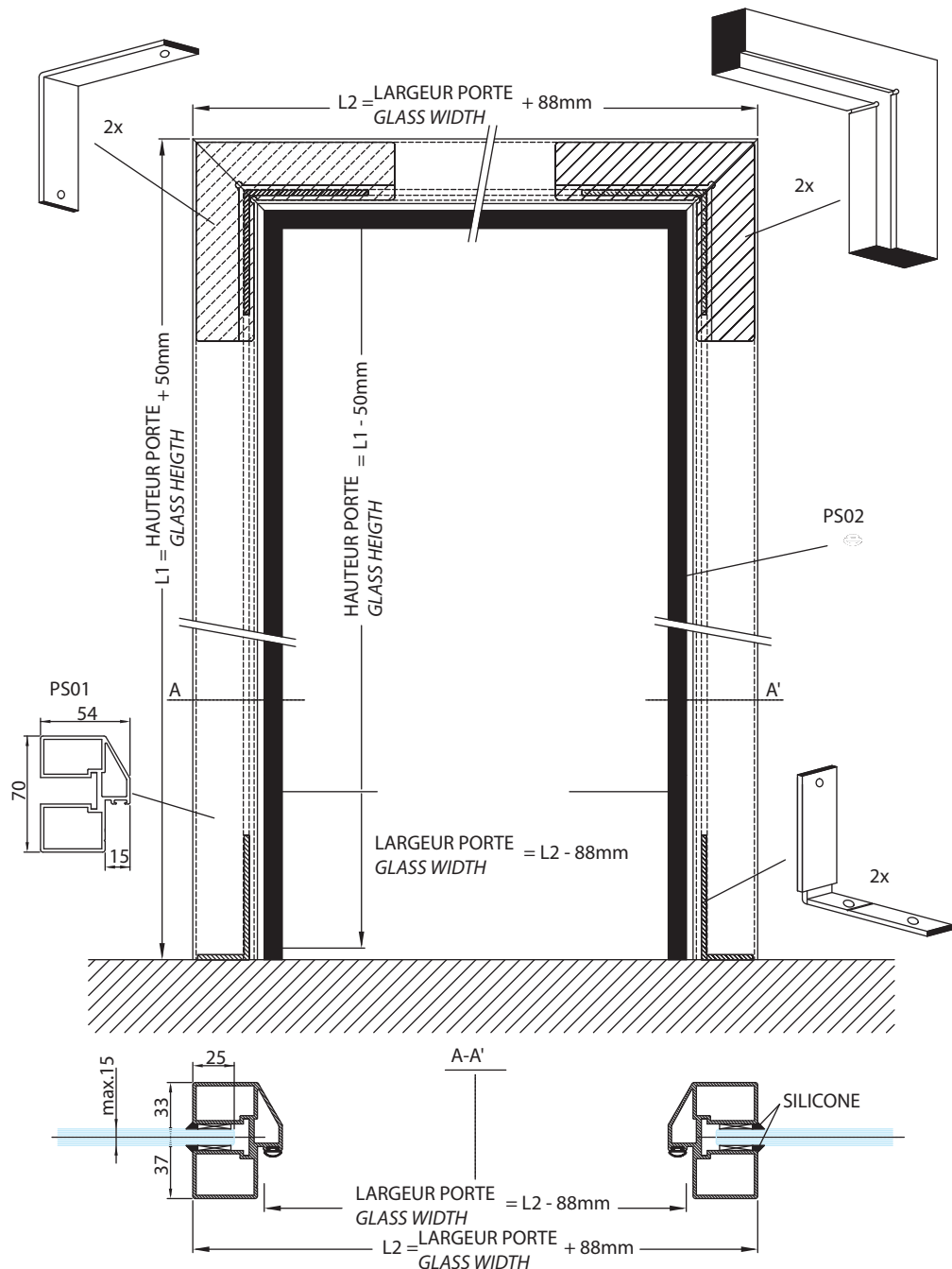



PS01MST



DIN GAUCHE / DIN LEFT

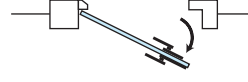

PS01MST/08L.XX

DIN DROITE / DIN RIGHT

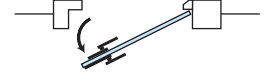

PS01MST/08R.XX

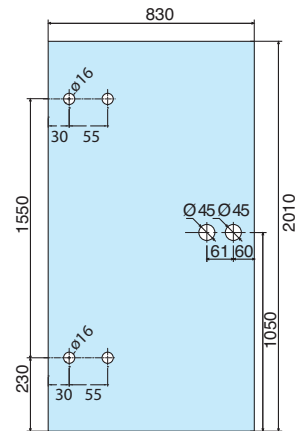

Références / References



Kit complet profil d'encadrement porte en verre de 830 x 2010 mm avec serrure V310 + V750 et paumelles V504
Complete Kit door frame profile for 830 x 2010 mm glass doors with lock V310 + V750 and hinges V504



Aluminium anodisé Argent Brossé
Brushed anodised alu silver



Aluminium anodisé Aninox
Brushed anodised alu.

DIN gauche DIN left

PS01MST/08L.12

PS01MST/08L.36

DIN droite DIN right

PS01MST/08R.12

PS01MST/08R.36

PS

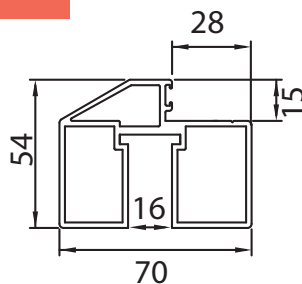

Références / References



Profil d'encadrement vertical longueur 2500 mm
2500 mm length profile for vertical door frame



Aluminium anodisé Argent Brossé
Brushed anodised alu silver



Aluminium anodisé Aninox
Brushed anodised alu.

PS2500.12

PS2500.36

Profil d'encadrement horizontal longueur 1500 mm
1500 mm length profile for horizontal door frame

PS1500.12

PS1500.36

PS02.99



Références / References

Joint pour encadrement porte en verre - le mètre
Rubber strip for door frame - per meter

PS09.99

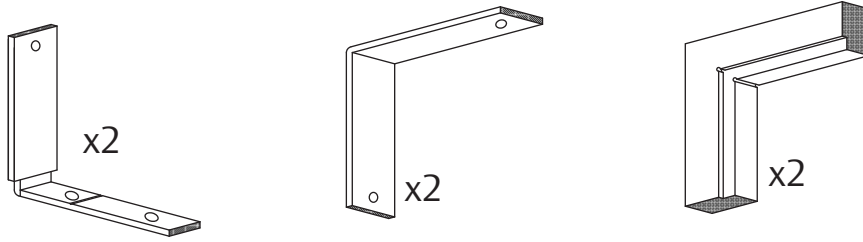

Serrures et
paumelles
Locksets and
hinges

Kit de fixation d'angle pour profil encadrement PS01, vis de fixation inclus
Corner mounting kit for doorframe profil PS01, including fixing screws

V504

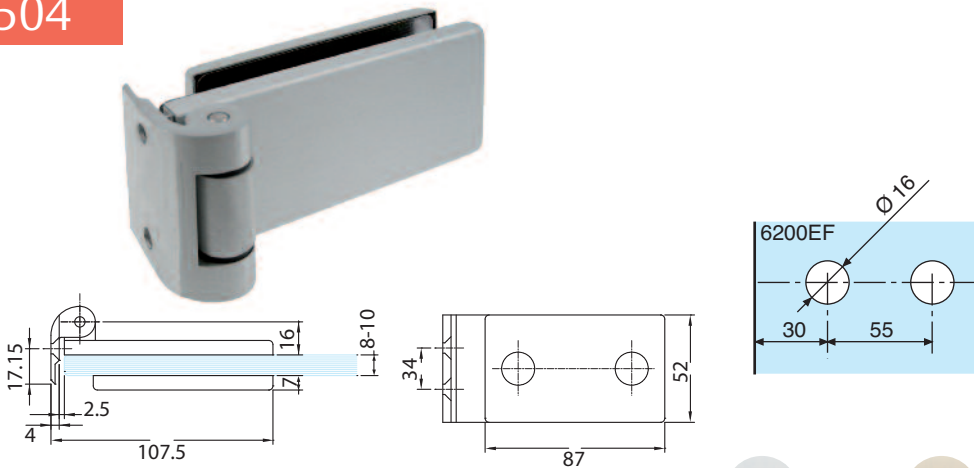

Références / References



Aluminium anodisé Argent Brossé / Brushed anodised alu silver
Aluminium anodisé Aninox / Brushed anodised alu.

Paumelle et fiche pour profil alu encadrement porte en verre PS01
Hinge and multi rebate butt for door frame aluminium profile for glass door PS01

V504.12

V504.36

RS02.99

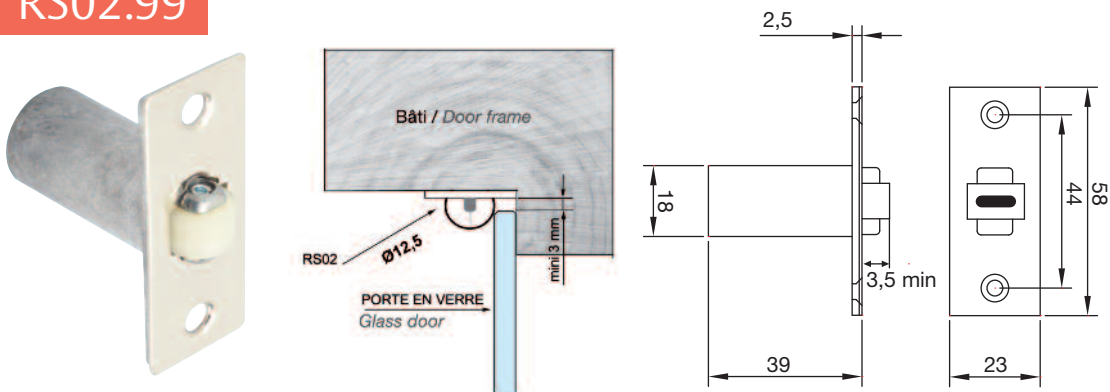

Galet avec rouleau nylon, réglable (3 à 10 mm)
Blocking roller keep, adjustable (3 to 10 mm)

2800.66.4

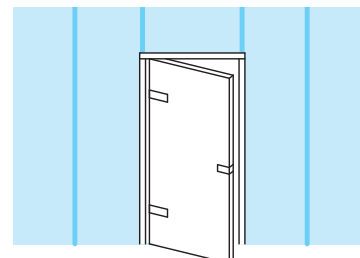
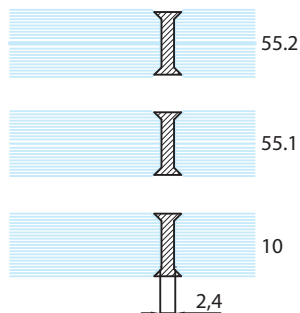
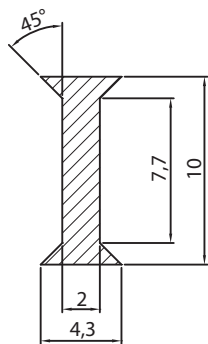

Références / References



Joint PVC pour verre 10 mm - 55,1 - 55,2 adhésif inclus pour joindre 2 panneaux fixes
Dry glazing profile for glass 10 mm - 55,1 - 55,2 including tape for jointing 2 fixed panels

2800.66.4

- Unité de vente : 1 joint conditionné par 10
- Sold in units : packed by 10

2800.66.5

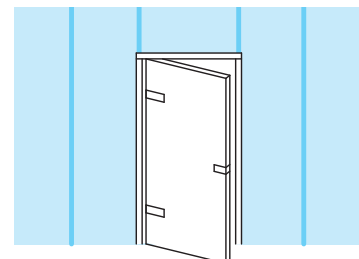
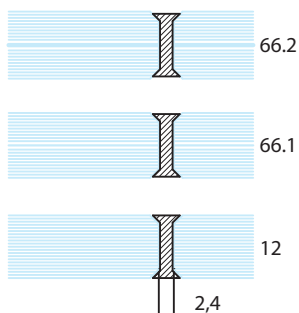
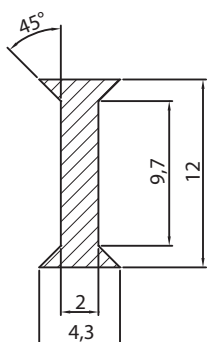

Références / References

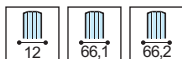

Joint PVC pour verre 12 mm - 66,1 - 66,2 adhésif inclus pour joindre 2 panneaux fixes
Dry glazing profile for glass 12 mm - 66,1 - 66,2 including tape for jointing 2 fixed panels

2800.66.5

- Unité de vente : 1 joint conditionné par 10
- Sold in units : packed by 10

LES + PRODUITS

Esthétique

Installation

Attractive design

Easy installation



Paumelles *Hinges*

Lagune & Lumira

Caractéristiques techniques

- Pour verre trempé de 8 à 10 mm
- Montage sur encoche 6200EF
- Dimension maximum des portes
827 mm x 2034 mm
- Poids maximum admissible 45 kg pour 2 paumelles,
pour un poids supérieur pose obligatoire
d'une 3ème paumelle

Technical features

- For 8 to 10 mm thick toughened glass
- To fit notch 6200EF
- Dimensions size of doors 827 mm x 2034 mm
- Max load 45 kg for 2 hinges, for load exceeding
a third hinge must be fitted



LES + PRODUITS

Design des serrures
Lagune et Lumira

*Lagune and Lumira
lock design*



4200

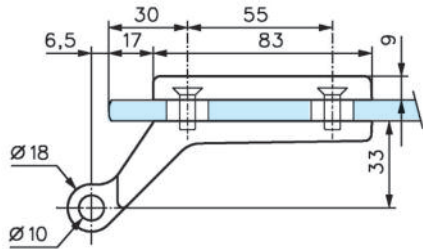
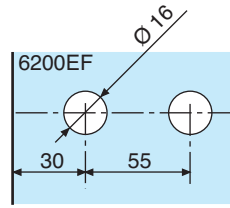

Références / References

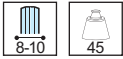

Chromé brillant
Bright chromium



Chromé mat
Matt chromium



Effet inox
Stainless steel effect



Doré
Gold plated



Laqué blanc 9010
Lacquered white RAL 9010

Paumelle pour feuillures de 35 à 40 mm,
s'utilise avec les fiches 3204 - 3205 - 3206
Hinge for rebate of 35 to 40 mm, to fit
butts 3204 - 3205 - 3206

4200.30.0

4200.31.0

4200.35.0

4200.40.0

4200.51.0

4201

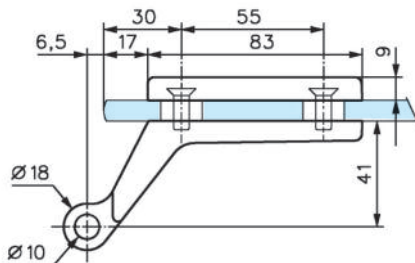
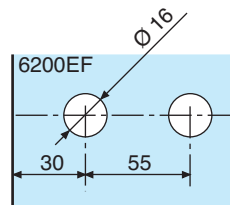

Paumelle pour feuillures supérieures
à 40 mm, s'utilise avec les fiches
3204 - 3205 - 3206
Hinge for rebate larger than 40 mm,
to fit butts 3204 - 3205 - 3206



Chromé brillant
Bright chromium



Chromé mat
Matt chromium



Effet inox
Brushed stainless steel



Doré
Gold plated



Laqué blanc 9010
Lacquered white RAL 9010

Références / References



4201.30.0

4201.31.0

4201.35.0

4201.40.0

4201.51.0



4201.31.5

Serrures et
paumelles
Locksets and
hinges

4203

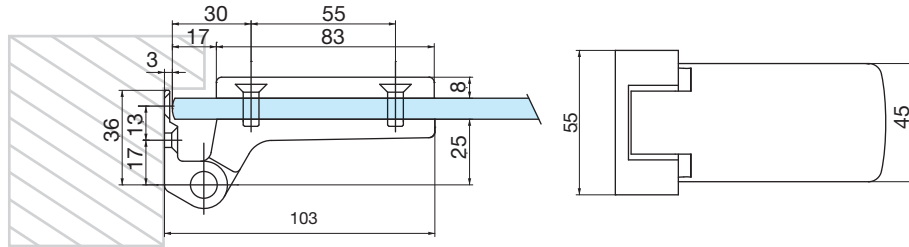
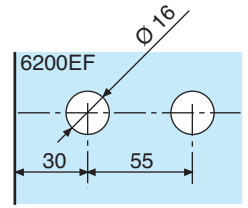

LES + PRODUITS

Montage facile
Tout support

Easy installation
Fits to all kinds
of frame

Références / References

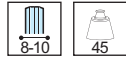

Chromé brillant
Bright chromium



Chromé mat
Matt chromium



Effet inox
Stainless steel effect



Doré
Gold plated



Laqué blanc 9010
Lacquered white RAL 9010

Paumelle et fiche multi feuillure pour
tous types d'huisseries
Hinge and multi rebate butt for all types
of frame

4203.30.0

4203.31.0

4203.35.0

4203.40.0

4203.51.0

V504

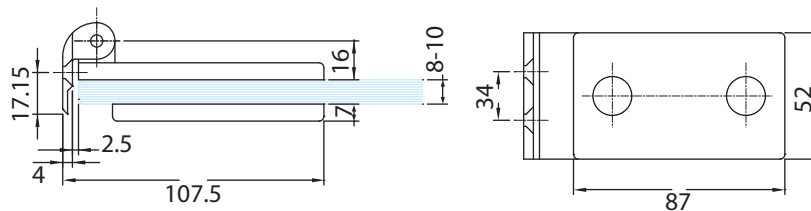
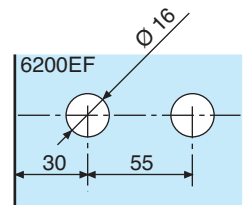

Références / References

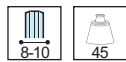

Aluminium anodisé Argent Brossé
Brushed anodised alu silver



Aluminium anodisé Aninox
Brushed anodised alu.

Paumelle et fiche pour profil alu encadrement porte en verre PS01
Hinge and multi rebate butt for door frame profile for glass door PS01

V504.12

V504.36

V505

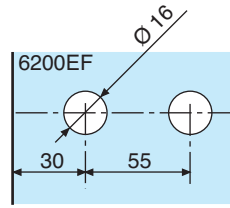

Serrures et
paumelles
Locksets and
hinges

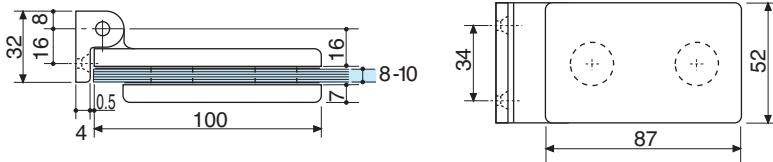

Références / References

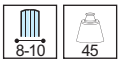

Laiton poli verni
Polished varnished brass



Aluminium anodisé Argent Brossé
Brushed anodised alu silver



Chromé brillant
Bright chromium



Chromé mat brossé
Brushed matt chromium



Aluminium anodisé Aninox
Brushed anodised alu.

Paumelle et fiche multi feuillure
pour tous types d'huisseries
Hinge and multi rebate butt for all
types of frame

V505.01

V505.12

V505.30.0

V505.33

V505.36

V507

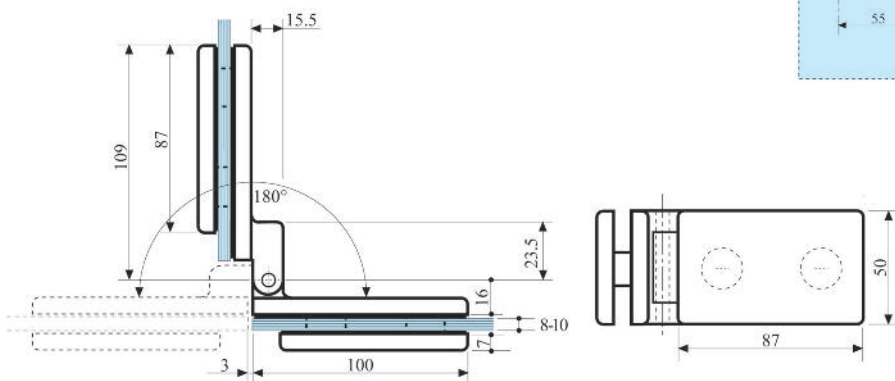
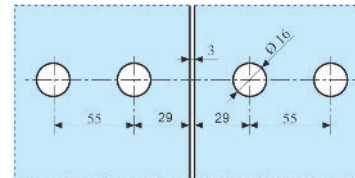

Références / References

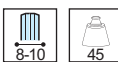

Laiton poli verni
Polished varnished brass



Aluminium anodisé Argent Brossé
Brushed anodised alu silver



Chromé brillant
Bright chromium



Chromé mat brossé
Brushed matt chromium



Aluminium anodisé Aninox
Brushed anodised alu.

Paumelle double verre/verre pour portes simple action
Glass to glass hinge for single action doors

V507.01

V507.12

V507.30.0

V507.33

V507.36

3204

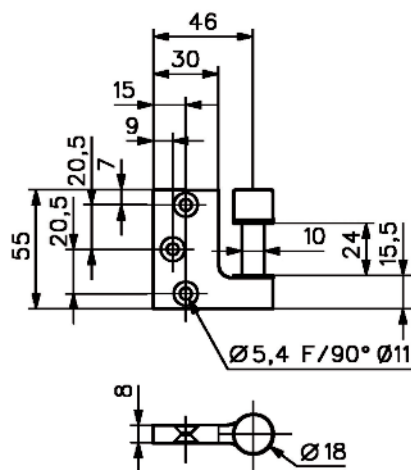

Chromé brillant
Bright chromium



Chromé mat
Matt chromium



Doré
Gold plated



Laqué blanc 9010
Lacquered white RAL 9010

Références / References

Fiche à entailler réversible pour huisseries bois,
s'utilise avec les paumelles 4200 et 4201
Reversible flush fixed butt for wooden door frame,
to fit to hinges 4200 and 4201

3204.30.0

3204.31.0

3204.40.0

3204.51.0

3206.**.0

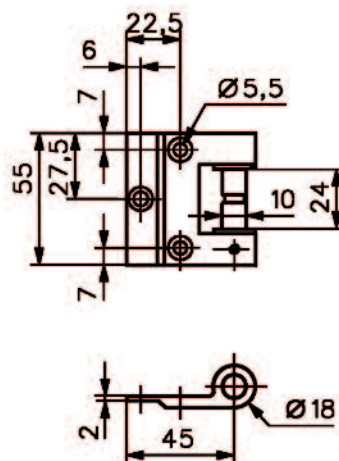

Références / References

Fiche en applique réversible pour toutes huisseries bois, métalliques et aluminium, s'utilise avec les paumelles 4200 et 4201
Reversible surface fixed butt for all types of wooden, metal and aluminium frame, to fit to hinges 4200 and 4201



Laiton poli
Polished brass



Chromé brillant
Bright chromium



Chromé mat
Matt chromium



Effet inox
Stainless steel effect



Doré
Gold plated



Laqué blanc 9010
Lacquered white RAL 9010

3206.00.0

3206.30.0

3206.31.0

3206.35.0

3206.40.0

3206.51.0

3205.**.1

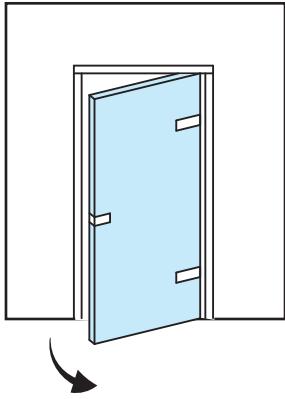
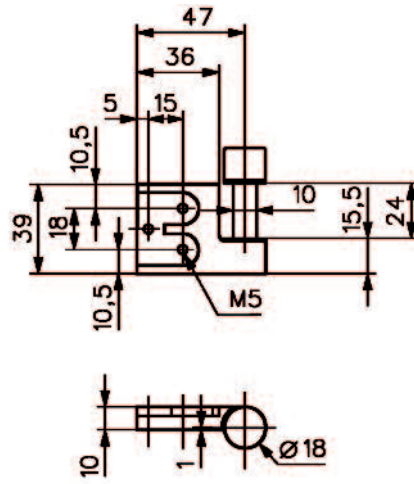

Références / References

Fiche à entailler (main droite) non réversible pour huisseries métalliques, s'utilise avec les paumelles 4200 et 4201

Non reversible mortised butt (right hand) for metal frame, to fit hinges 4200 and 4201

Chromé mat
Matt chromium

3205.31.1

3205.**.2

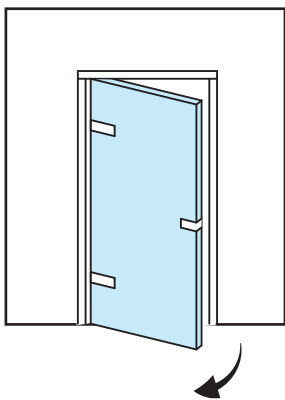
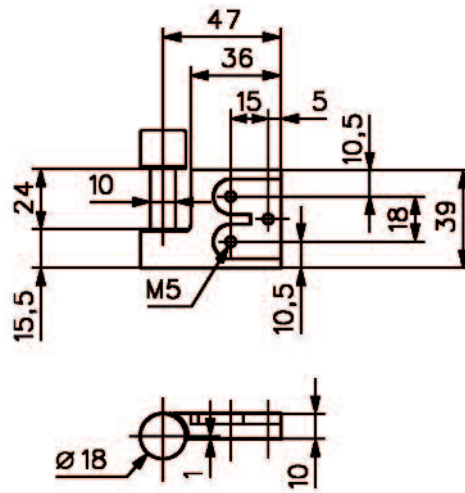

Références / References

Fiche à entailler (main gauche) non réversible pour huisseries métalliques, s'utilise avec les paumelles 4200 et 4201

Non reversible mortised butt (left hand) for metal frame, to fit hinges 4200 and 4201

Chromé mat
Matt chromium

3205.31.2

Paumelles *Hinges*

Bastille



Caractéristiques techniques

- Pour verre trempé de 8, 10 et 12 mm
- Montage sur encoche 6202EX
- Poids maximum admissible 45 kg pour 2 paumelles, largeur maximum 1000 mm, pour un poids supérieur nous consulter

Technical features

- For 8, 10 and 12 mm thick toughened glass
- To fit notch 6202EX
- Max load 45 kg, maximum width 1000 mm, for 2 hinges please consult us for glass weighting more than 45 kg

LES + PRODUITS

Montage facile
Tout support

Easy installation
Fit to all kind of frame

4202

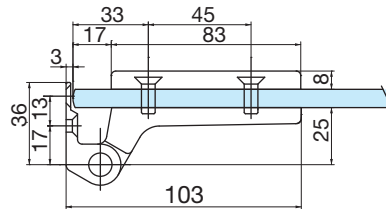
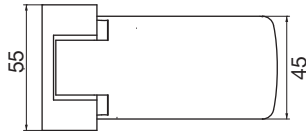
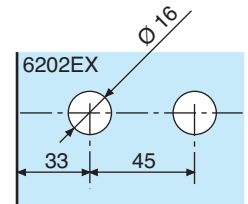

Références / References

Paumelle et fiche multi feuillure pour tous types d'huisseries
Hinge and multi rebate butt for all types of frame



Laiton poli PVD
Polished brass PVD



Chromé brillant
Bright chromium



Chromé mat
Matt chromium



Effet inox
Stainless steel effect



4202.05.0

4202.30.0

4202.31.0

4202.35.0



4202.31.5

4202.35.5

4206

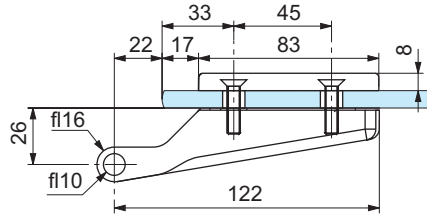
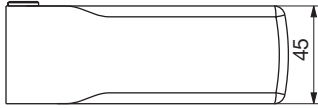
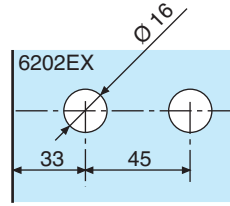

Références / References



Chromé brillant
Bright chromium

4206.30.0



Chromé mat
Matt chromium

4206.31.0



Effet inox
Stainless steel effect

4206.35.0

Paumelle pour feuillure de 24 mm,
s'utilise avec les fiches 4207 - 4208 - 4209
Hinge for rebate of 24 mm, to fit butts
4207 - 4208 - 4209

V505.2

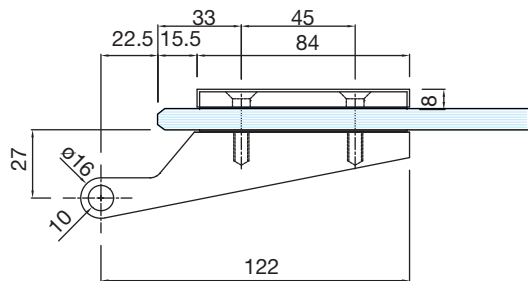
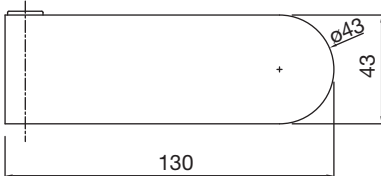
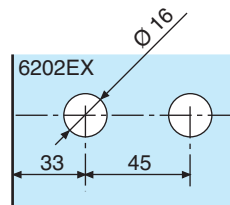

Références / References



Aluminium anodisé Argent Brossé
Brushed anodised alu silver

V505.2.12



Aluminium anodisé Aninox
Brushed anodised alu.

V505.2.36

Paumelle pour feuillure de 24 mm, s'utilise
avec les fiches 4207 - 4208 - 4209
Hinge for rebate of 24 mm, to fit butts
4207 - 4208 - 4209

4208.99.0

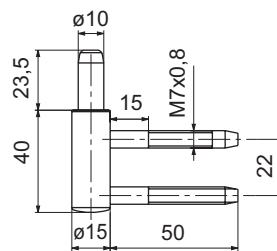
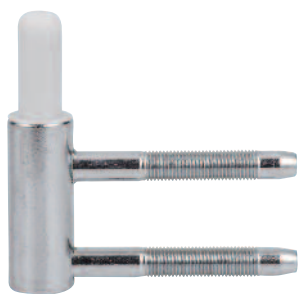

Fiche pour huisseries bois, s'utilise avec la paumelle 4206 et caches fiches 4205
Butt for wooden door frame, to fit hinge 4206 and butt covers 4205



K3172.99

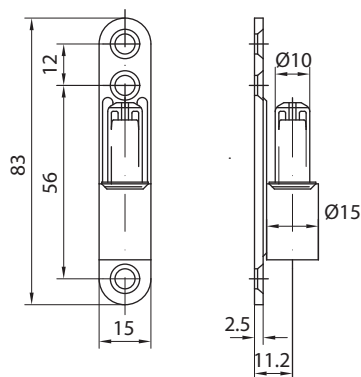

Fiche en applique réversible pour toutes huisseries bois, métalliques et aluminium, s'utilise avec les paumelles 4206 – V505.2 et caches fiches 4205 – V207
Reversible surface fixed butt for all types of wooden, metal and aluminium frame, to fit hinges 4206 – V505.2 and butt covers 4205 – V207

4205

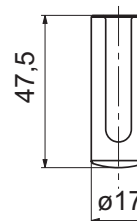

Références / References

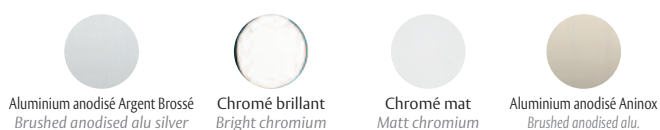
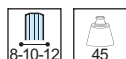

Caches pour fiches 4207 - 4208 - 4209
Covers for butt 4207- 4208 - 4209

4205.12.0

4205.30.0

4205.31.0

4205.36.0

Paumelles *Hinges*

Serrures et
paumelles
Locksets and
hinges

Vertis

Caractéristiques techniques

- Pour verre trempé de 8 et 10 mm
- Montage sur encoche V380E
- Poids maximum admissible 45 kg pour 2 paumelles, largeur maximum 1000 mm, pour un poids supérieur nous consulter

Technical features

- For 8 and 10 mm thick toughened glass
- To fit notch V380E
- Max load 45 kg, maximum width 1000 mm, for 2 hinges please contact us for glass weighing more than 45 kg

V381

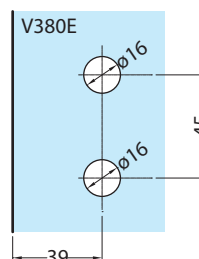
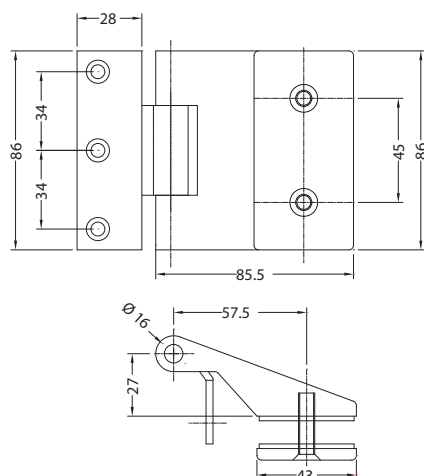

Références / References

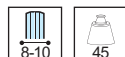

V381.12

V381.15

Paumelle et fiche pour feuillure de 35 mm
Hinge and butt for rebate of 35 mm

V506

Caractéristiques techniques

- Montage sur encoche V506 E
- Poids maximum admissible 55 kg pour 2 paumelles, largeur maximum 900 mm, pour un poids

Technical features

- To fit notch V506E
- Max load 55 kg, maximum width 900 mm, for 2 hinges please contact us for glass weighing more than 55 kg

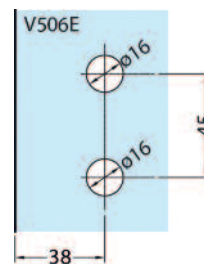
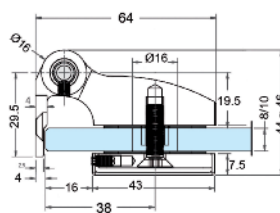
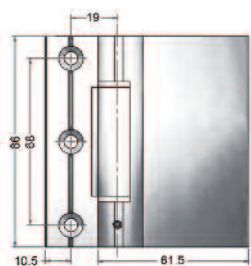

Références / References

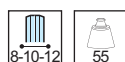

V506.12

V506.36

Paumelle et fiche multi feuillure pour tous types d'huissieries
Hinge and multi rebate butt for all types of frame

Freeline

Charnière hydraulique Hydraulic hinge

Caractéristiques techniques

- Recommandé pour porte intérieure
- Dimensions maxi de la porte 1000 x 3000 mm
- Poids maximum admissible 100 kg pour 2 charnières
- Pour verre trempé de 8, 10 et 12 mm
- Blocage à 90° et retour hydraulique de 80° à 0° dans les 2 sens.
- Réglage possible du point 0 de la porte
- Vitesse de fermeture réglable
- Montage sur encoche 4961E1 pour la charnière simple 4961 et encoche 4962E pour la charnière double 4962
- Livré avec joints et vis de fixation inox

Technical features

- Recommended for inside doors
- Maximum door size 1000 x 3000 mm
- Max. load 100 kg for 2 hinges
- For 8, 10 or 12mm thick toughened glass
- Blocking at 0° and 90° with hydraulic return from 80° to 0° on both sides.
- Adjustable in the closed position
- Adjustable closing speed
- To fit notch 4961E1 for single hinge 4961 and notch 4962E for double hinge 4962
- Supplied with spacers and stainless steel fixing screws

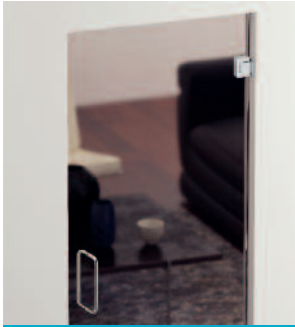

LES + PRODUITS

Système hydraulique pour un confort et une souplesse de fermeture automatique

Solution esthétique

Vitesse de fermeture réglable

Porte 100kg maxi

Installation facile

Hydraulic system for comfort in automatic door closing

Aesthetic solution

Adjustable closing speed

For glass door 100kg

Easy installation

4961.**.OSQ

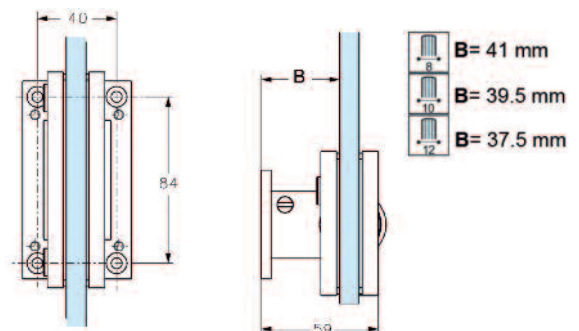
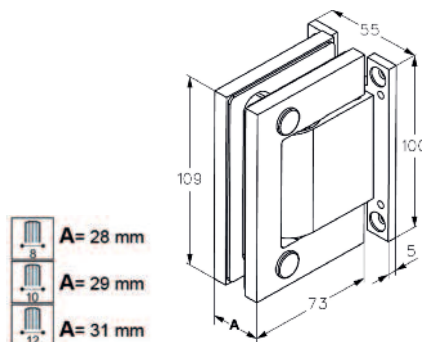
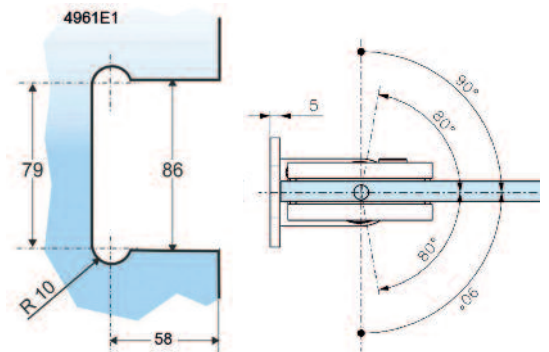

Références / References



Charnière simple hydraulique fixation murale avec 4 trous
Single hydraulic hinge wall plate with 4 fixing holes



Aluminium anodisé Argent Brossé
Brushed anodised alu silver



Chromé brillant
Bright chromium



Aluminium anodisé Aninox
Brushed anodised alu.

4961.12.OSQ

4961.30.OSQ

4961.36.OSQ

4962.**.OSQ

Serrures et
paumelles
Locksets and
hinges

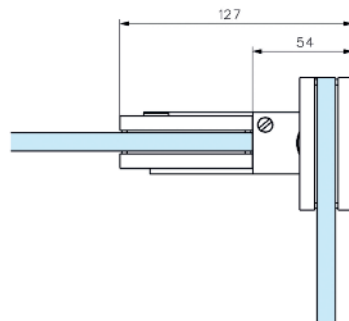
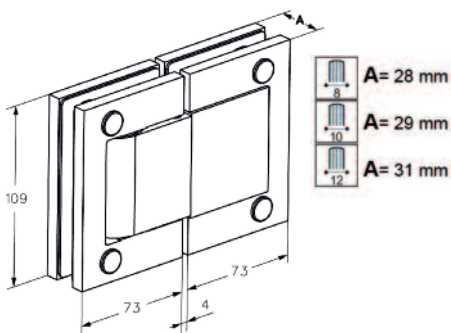
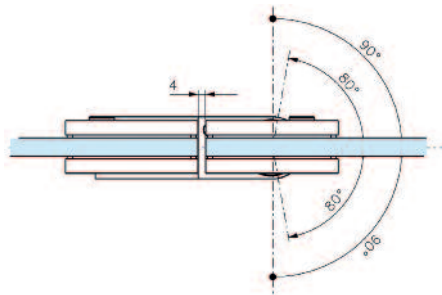
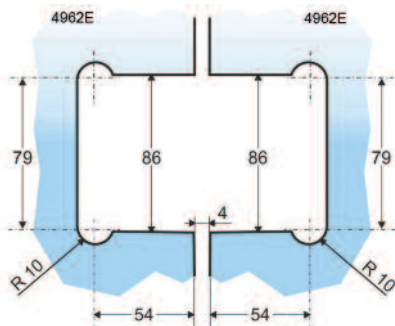

Références / References



Aluminium anodisé Argent Brossé
Brushed anodised alu silver



Chromé brillant
Bright chromium



Aluminium anodisé Aninox
Brushed anodised alu.

Charnière double verre/verre à rappel hydraulique
Glass to glass hydraulic return hinge

4962.12.OSQ

4962.30.OSQ

4962.36.OSQ

Swingo

Caractéristiques techniques

- Blocage à 90°
- Pour verre trempé de 8 et 10 mm
- Poids maximum admissible 60 kg pour 2 charnières
- Largeur maximum de la porte 900 mm
- Montage sur encoche V861E
- Livrée avec joints et vis de fixation
- Réglage possible du point 0 pour le 4861

Technical features

- Blocking points at 90°
- For 8 and 10 mm thick toughened glass
- Max load 60 kg for 2 hinges
- Width of the door 900 mm
- Assembly on notch V861E
- Delivered with spacers and fixing screws

LES + PRODUITS

The + product

Design

Fermeture
automatique
de la porte

Installation facile
et discrète

Elegant design

Automatic door closing

*Easy and discreet
installation*



4861

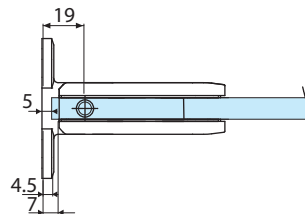
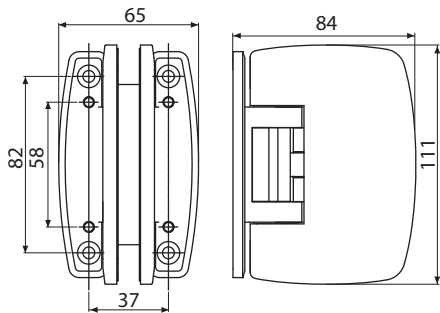
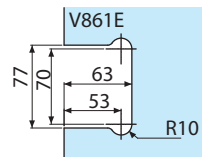

Références / References



Chromé brillant
Bright chromium



Chromé mat
Matt chromium



Effet inox
Stainless steel effect

Charnière simple mur/verre à rappel automatique
Single hinge wall/glass automatic return

4861.30.0

4861.31.0

4861.35.0

4862

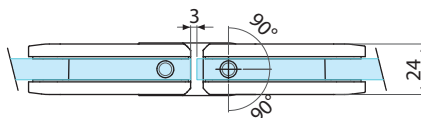
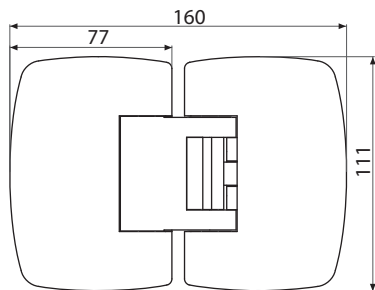
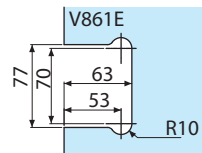

Références / References



Chromé brillant
Bright chromium



Chromé mat
Matt chromium



Effet inox
Stainless steel effect

Charnière double verre/verre à rappel automatique
Glass to glass automatic return hinge

4862.30.0

4862.31.0

4862.35.0

Serrures et
paumelles
Locksets and
hinges

Pentures *Hinges* Lumira

Caractéristiques techniques

- Pour verre trempé épaisseur 8, 10 et 12 mm
- Poids maximum admissible 75 kg
- Dimensions maxi pour portes en verre 900 x 2200 mm
- Montage sur encoche V590E
- Jeu sur la hauteur du sol au plafond H - 14 mm

Technical features

- For 8, 10 and 12 mm thick toughened glass
- Max load 75 kg
- Maximum size for glass doors 900 x 2200 mm
- Assembly on notch V590E
- Allow -14 mm on the height from ground to ceiling H

LES + PRODUITS

The + product

Idéal pour portes
lourdes ou
grand format

*Ideal for heavy and
large doors*

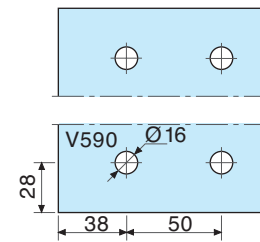
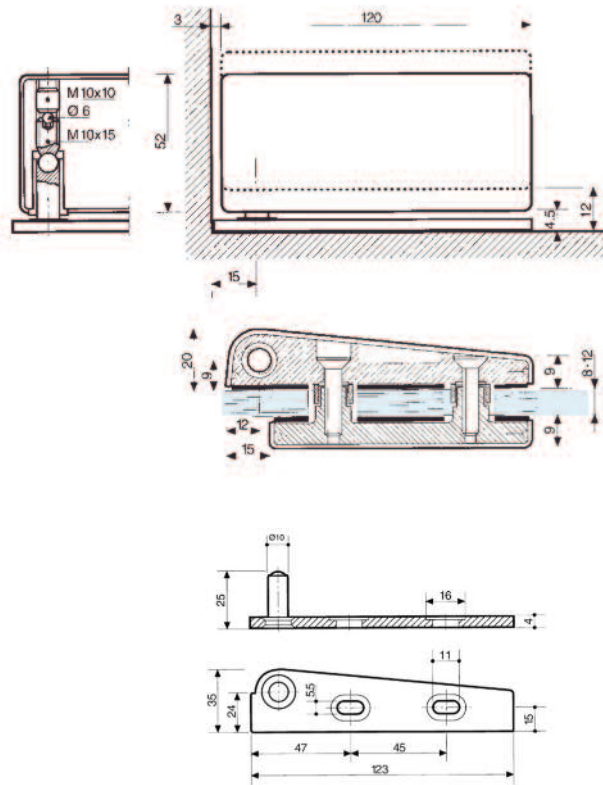

JEUX RECOMMANDÉS RECOMMENDED TOLERANCES

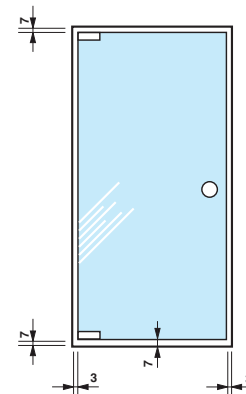

V590

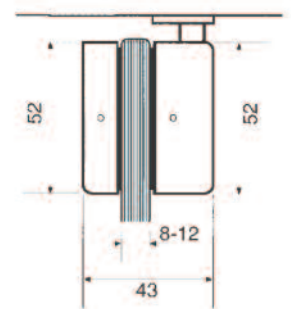

Références / References

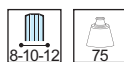

Pentures déportées basse et
haute avec platines

*Top and bottom offset pivot
hinges with mounting plate*



Aluminium anodisé Argent Brossé
Brushed anodised alu silver

V590.12



Aluminium anodisé Aninox
Brushed anodised alu.

V590.36

Loqueteaux

Caractéristiques techniques

- Ne nécessite aucune encoche, sauf réf V529 et V539
- Se pose sur le chant du verre, jeu minimum 4 mm
- Blocage du pêne en position sortie ou rentrée
- Pour verre trempé de 8, 10 et 12 mm
- Livrée avec gâche plate (2 clés pour réf 1448)

Technical features

- Requires no notch, except ref V529 and V539
- Fixing on edge of door, minimum space 4 mm
- Bolt can be blocked in the projecting or retracted position
- For 8, 10 and 12 mm thick toughened glass
- Supplied with flat keep (2 keys for ref 1448)

1445

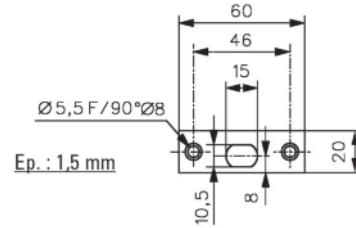
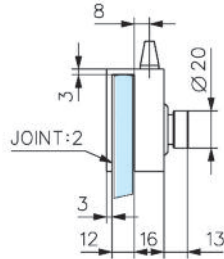
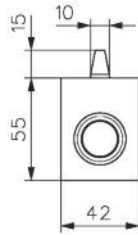

Références / References



Loqueteau à bouton
Clip on lock with notch



Laiton poli
Polished brass



Chromé brillant
Bright chromium



Chromé mat
Matt chromium

1445.00.0

1445.30.0

1445.31.0

1446

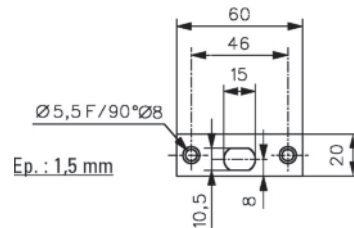
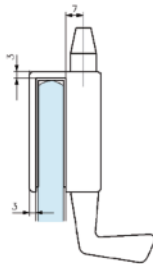
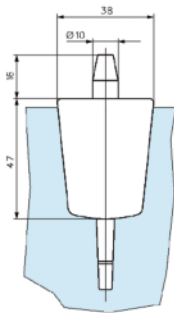

Références / References

Loqueteau à tirage
Clip on lock with
pull catch



Laiton poli PVD
Polished brass PVD



Chromé brillant
Bright chromium



Chromé mat
Matt chromium



Effet inox
Stainless steel effect



Laqué Blanc
Lacquered white RAL 9010

1446.05.0

1446.30.0

1446.31.0

1446.35.0

1446.51.0



1446.30.5

1446.31.5

Loqueteaux
Clip-on locks

1448

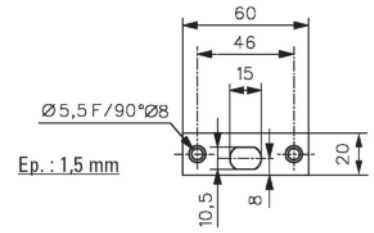
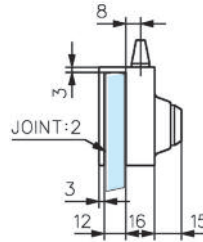
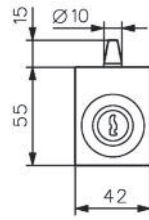

Références / References



Loqueteau à clé
Clip on lock with cylinder



Laiton poli
Polished brass



Chromé brillant
Bright chromium



Chromé mat
Matt chromium

1448.00.0

1448.30.0

1448.31.0



LES + PRODUITS

The + product

Idéal pour portes
semi-fixe

Ideal for semi-fixed
doors

1447

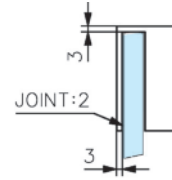

Références / References



Boîtier gâche pour loqueteaux série 1445/1448
Matching patch keep for clip on lock series 1445/1448



Laiton poli
Polished brass



Chromé brillant
Bright chromium



Chromé mat
Matt chromium

1447.00.0

1447.30.0

1447.31.0

1449

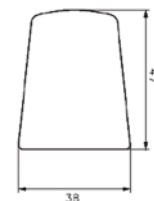
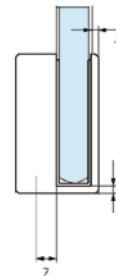

Références / References



Boîtier gâche pour
loqueteaux série 1446
Matching patch keep for
clip on lock series 1446



Chromé brillant
Bright chromium



Chromé mat
Matt chromium

1449.30.0

1449.31.0