



DIVINA PORTA

DIVINA HINGED DOOR - DIVINA DREHTÜR

SEMPLICE: Divina porta battente è un concentrato di semplicità. Il sistema esclusivo di assemblaggio dei profili e degli accessori e l'assenza di lavorazioni meccaniche permettono la costruzione di porte a misura, sempre diverse tra loro, utilizzando i più comuni strumenti di lavoro.

DUREVOLE: I migliori materiali insieme alle più moderne tecniche di trattamento delle superfici, rendono Divina Battente un prodotto solido e resistente.

BELLO ED ELEGANTE: basta guardarlo!

EASY: Divina hinged door is a concentrate of simplicity. The exclusive assembly system of profiles and accessories and the absence of mechanical processing allow the construction of custom-made doors, always different from each other, using the most common work tools.

DURABLE: The best materials together with the most modern surface treatment techniques make Divina Battente a solid and resistant product.

BEAUTIFUL AND ELEGANT: just look at it!

EINFACH: Divina Drehtür ist ein Konzentrat der Einfachheit. Das exklusive Montagesystem von Profilen und Zubehör und die Absenz von mechanische Bearbeitung ermöglichen den Bau von Türen nach Maß, die sich immer voneinander unterscheiden, mit den gängigsten Arbeitswerkzeugen.

HALTBAR: Die besten Materialien zusammen mit den modernsten Oberflächenbehandlung Techniken machen Divina Battente zu einem soliden und beständigen Produkt.

SCHÖN UND ELEGANT: Schau es Sie einfach an!

DIVINA PORTA



DIV-030-740 **PRICE LIST pag. 2** ▶ **DC01**

SET COMPLETO ANTA INTELAIATA DIVINA
 DIVINA FRAMED HINGED DOOR COMPLETE SET
 KOMPLETT-SET DIVINA GERAHMTE DREHTÜR

—

NO
 FINITURA - FINISHING - OBERFLÄCHE

COMPONENTI - COMPONENTS - EINZELTEILE:

DIV-100 MANIGLIA - HANDLE - GRIFF
 ANTA - PANEL - TÜR
 —

V-740 P-030
 SERRATURA COMPATTA ORIZZONTALE STIPITE - DOOR JAMB - ZARGE
 HORIZONTAL COMPACTED LOCK
 HORIZONTALES KOMPAKTES SCHLOSS

DIV-100

DIMENSIONE PROFILI - PROFILE DIMENSION - PROFILGRÖSSE

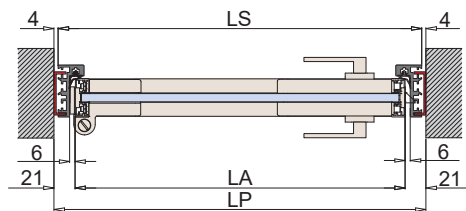
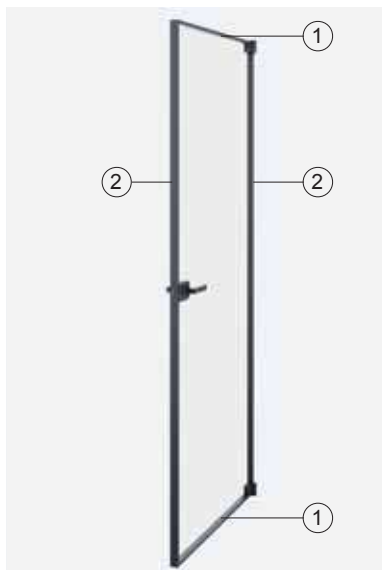

Biadesivo preinstallato
Pre-installed double-sided adhesive
Selbstklebend



DIV-204 OPTIONAL
TRAVERSINO
CROSS PROFILE
QUERPROFIL

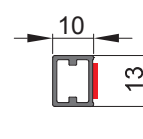

①
DIV-103
TRAVERSO SUPERIORE E INFERIORE
HORIZONTAL TOP AND BOTTOM PROFILE
HORIZONTAL TOP AND BOTTOM PROFILE
UNTERES UND OBERES HORIZONTALES PROFIL



②
DIV-102
MONTANTE VERTICALE
VERTICAL PROFILE
VERTICAL PROFILE
SENKRECHTES PROFIL

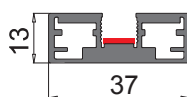

xme595m
xme636f/u

DIV-100-S2FLG + DIV-100-F2FLG

DIMENSIONE PROFILI - PROFILE DIMENSION - PROFILGRÖSSE

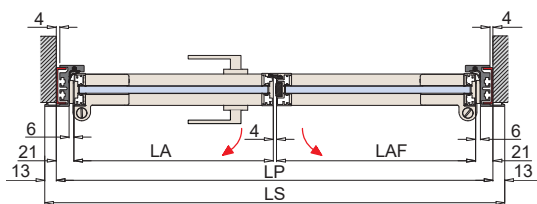
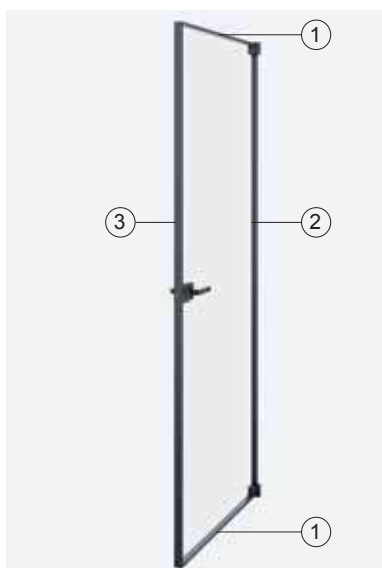

Biadesivo preinstallato
Pre-installed double-sided adhesive
Selbstklebend

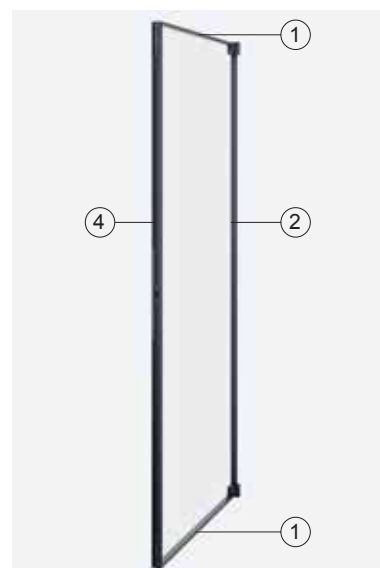

①
DIV-103
TRAVERSO SUPERIORE E INFERIORE
HORIZONTAL TOP AND BOTTOM PROFILE
HORIZONTAL TOP AND BOTTOM PROFILE
UNTERES UND OBERES HORIZONTALES PROFIL



②
DIV-102
MONTANTE VERTICALE
VERTICAL PROFILE
VERTICAL PROFILE
SENKRECHTES PROFIL

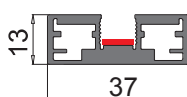

③
DIV-105
MONTANTE VERTICALE
(porta doppia lato serratura)
VERTICAL PROFILE
(double hinged door, lock side)
VERTICAL PROFILE
(2 FLG - Schlossseite)

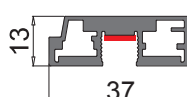

④
DIV-104
MONTANTE VERTICALE
(porta doppia lato contropiastra)
VERTICAL PROFILE
(double hinged door, strike plate side)
VERTICAL PROFILE
(2 FLG - Schließblechseite)

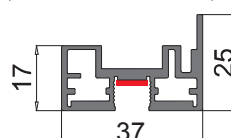

DIV-204 OPTIONAL
TRAVERSINO
CROSS PROFILE
QUERPROFIL

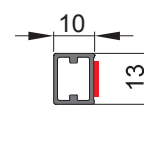

ESCLUSIVE DEL PROGETTO

EXCLUSIVE FEATURES OF THE PROJECT - EXKLUSIV FÜR DAS PROJEKT

- Utilizzo dell'esclusivo programma MyMetalglas per lo sviluppo delle porte. **Misure vetri, profili e lavorazioni con un solo click.**
- Biadesivo preinstallato. **Assemblaggio immediato** senza l'utilizzo di alcun tipo di collante e quindi **eliminazione totale della pulizia del vetro** post assemblaggio dell'anta.
- Dima di foratura: tagli i profili da nostra distinta e con la dima fori **senza possibilità di errori.**
- Use of the exclusive MyMetalglas program for door design. **Glass measurements, profiles and processes with a single click.**
- Pre-installed double-sided adhesive. **Straightforward assembly without the use of any type of glue.** NO glass cleaning.
- Drilling template: cut the profiles as per our specifications **and use the drilling template to make error-free holes.**
- Nutzung des exklusiven Programms MyMetalglas für die Türplanung. **Glasabmessungen, Profile und Verarbeitungen mit einem Klick.**
- Selbstklebend. Sofortige Montage ohne die Verwendung von Klebstoff jeglicher Art. **Glasreinigung NICHT MEHR NOTWENDIG.**
- Bohrschablone: schneiden Sie die Profile **und bohren Sie mit der Schablone ohne Fehlerrisiko.**

GAMMA FINITURE

FINISHING RANGE - OBERFLÄCHEN-SORTIMENT



Un sistema vincente, rapido e sicuro per l'allineamento e l'assemblaggio dei profili.

A winning, fast and safe system for aligning and assembling profiles.

Ein optimales, schnelles und sicheres System zur Profilausrichtung und -montage.

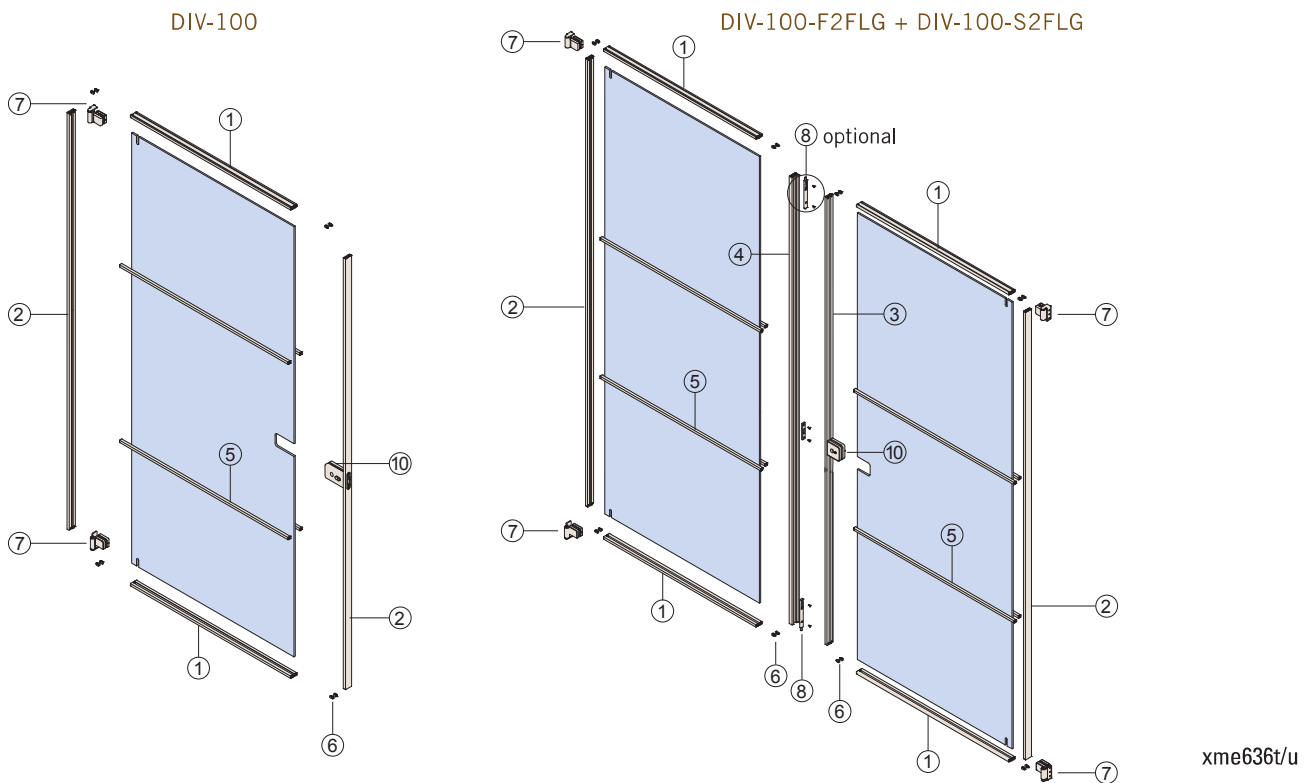

①
DIV-103
TRAVERSO SUPERIORE
E INFERIORE
HORIZONTAL TOP
AND BOTTOM PROFILE
UNTERES UND OBERES
HORIZONTALES PROFIL

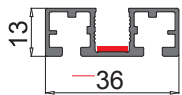

②
DIV-102
MONTANTE VERTICALE
VERTICAL PROFILE
SENKRECHTES PROFIL

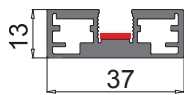

③
DIV-105
MONTANTE VERTICALE
(porta doppia lato serratura)
VERTICAL PROFILE
(double hinged door, lock side)
SENKRECHTES PROFIL
(2 FLG – Schlossseite)

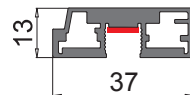

④
DIV-104
MONTANTE VERTICALE
(porta doppia lato contropiastra)
VERTICAL PROFILE
(double hinged door, strike plate side)
SENKRECHTES PROFIL
(2 FLG – Schließblechseite)

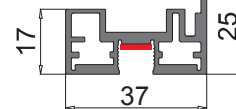

⑤
DIV-204 OPTIONAL
TRAVERSINO
CROSS PROFILE
QUERPROFIL

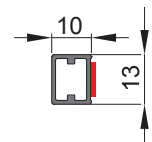

⑥
P-F37
KIT ASSEMBLAGGIO
ASSEMBLY KIT
MONTAGE-KIT



⑦
DIV-V742
PAIO CERNIERE
PAIR HINGES
PAAR BÄNDER

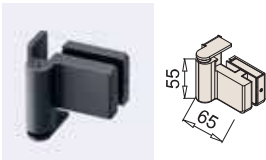

⑧
DIV-003
CATENACCIOLO
LOCKING BOLT
FESTSTELLER

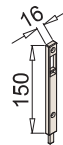

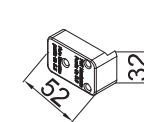

⑨
DIV-04
DIMA FORATURA
DRILLING TEMPLATE
BOHRSCHABLONE

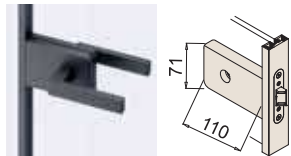

 Biadesivo preinstallato
Pre-installed
double-sided adhesive
Selbstklebend

⑩
V-740 UV / MV-740 UV 
SERRATURA COMPATTA
COMPACTED LOCK
KOMPAKTES SCHLOSS



⑩
V-740 WC / MV-740 WC 
SERRATURA COMPATTA WC
COMPACTED LOCK WITH WC THUMB TURN
KOMPAKTES SCHLOSS MIT WC RIEGELKNOPF



⑩
V-741 PZ
SERRATURA VERTICALE
VERTICAL LOCK
VERTIKALES SCHLOSS

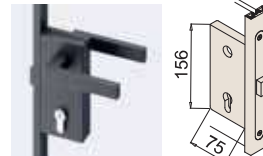

⑩
DIV-M101
MANIGLIETTA A TIRARE
SMALL HANDLE
KLEINE GRIFFE

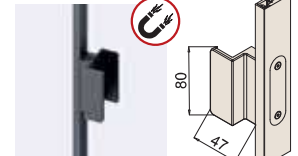

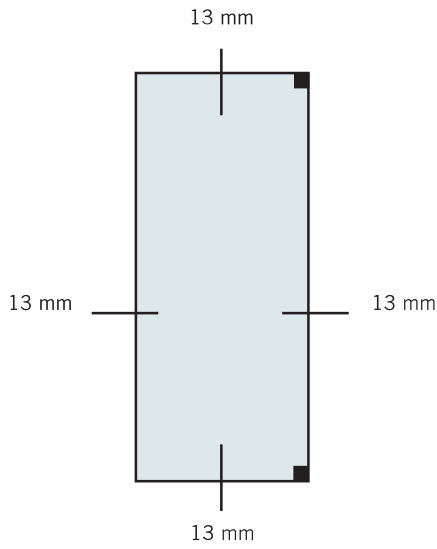

DIV-100

Anta Intelaiata - Framed panel - Gerahmte Tür

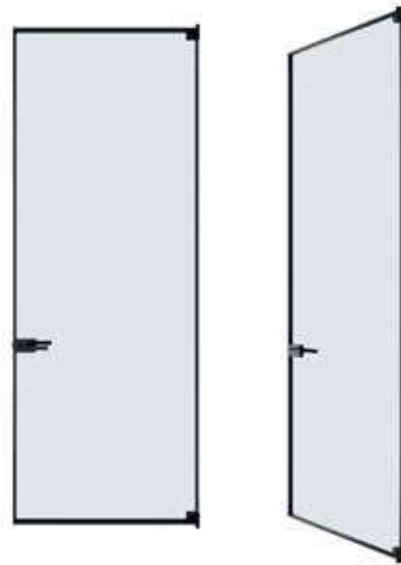

POSSIBILI CONFIGURAZIONI - POSSIBLE CONFIGURATION - MÖGLICHE KONFIGURATIONEN

Anta Intelaiata con listelli trasversali - Framed panel with horizontal cross profiles - Gerahmte Tür mit Querleisten

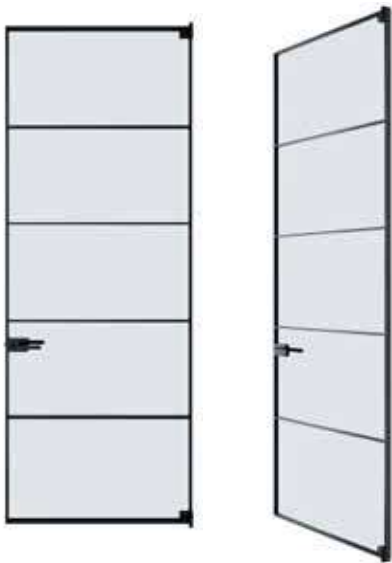

Anta Intelaiata con listelli trasversali e verticali - Framed panel with horizontal and vertical cross profiles - Gerahmte Tür mit Quer und Vertikalleisten

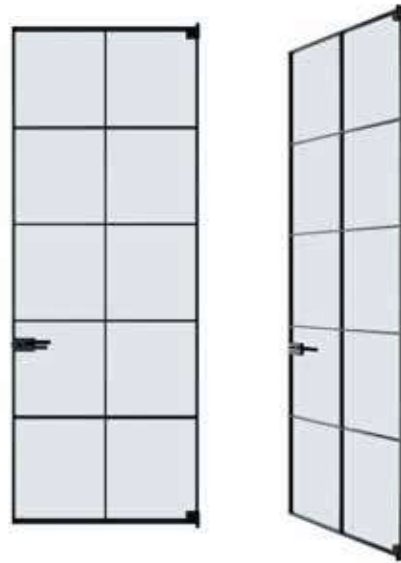

Anta Intelaiata con listelli tutti verticali - Framed panel with vertical cross profiles only - Gerahmte Tür nur mit Vertikalleisten

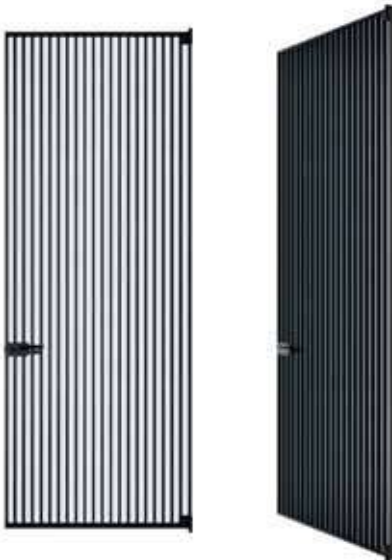

Anta Intelaiata con listelli tutti trasversali - Framed panel with horizontal cross profiles only - Gerahmte Tür nur mit Querleisten





FINITURE - FINISHES - OBERFLÄCHEN







DIV-030-740 PRICE LIST pag. 2 ▶ DC01

SET COMPLETO ANTA INTELAIATA DIVINA
 DIVINA FRAMED HINGED DOOR COMPLETE SET
 KOMPLETT-SET DIVINA GERAHMTE DREHTÜR

COMPONENTI - COMPONENTS - EINZELTEILE:

DIV-100

ANTA - PANEL - TÜR

V-740

SERRATURA COMPATTA ORIZZONTALE
 HORIZONTAL COMPACTED LOCK
 HORIZONTALES KOMPAKTES SCHLOSS

MANIGLIA - HANDLE - GRIFF

P-030

STIPITE - DOOR JAMB - ZARGE

NO + BC

FINITURA - FINISHING - OBERFLÄCHE

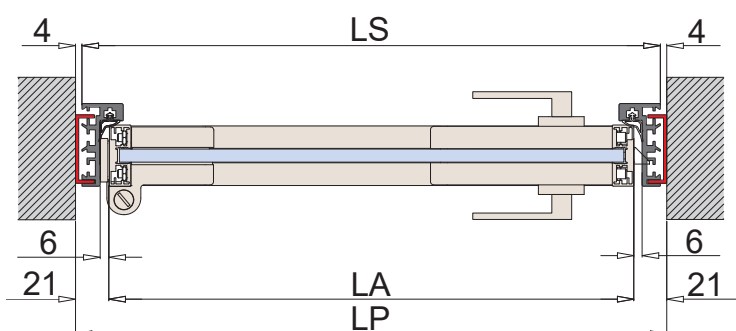



DIV-030-2FLG-740 **PRICE LIST pag. 2 ▶ DC02**

SET COMPLETO PORTA DOPPIA INTELAIATA DIVINA
 DIVINA DOUBLE FRAMED HINGED DOOR COMPLETE SET
 KOMPLETT-SET DIVINA 2 FLÜGELIGE GERAHMTE DREHTÜR

NO

FINITURA - FINISHING - OBERFLÄCHE

COMPONENTI - COMPONENTS - EINZELTEILE:

DIV-100-S2FLG

ANTA BATTENTE
 HINGED ACTIVE DOOR
 GEHFLÜGEL

DIV-100-F2FLG

ANTA SEMIFISSA
 HINGED INACTIVE DOOR
 STANDFLÜGEL

V-740

SERRATURA COMPATTA ORIZZONTALE
 HORIZONTAL COMPACTED LOCK
 HORIZONTALES KOMPAKTES SCHLOSS

MANIGLIA - HANDLE - GRIFF

P-030

STIPITE - DOOR JAMB - ZARGE

DIV-204 (optional)

LISTELLO - CROSS PROFILE - QUERPROFIL

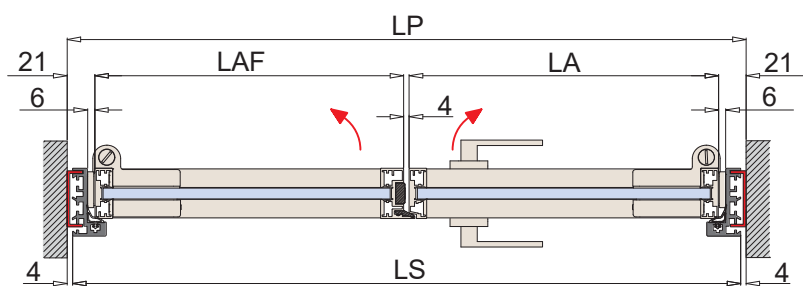





DIV-300-740 PRICE LIST pag. 4 ▶ DC07

SET COMPLETO ANTA INTELAIATA DIVINA
 DIVINA FRAMED HINGED DOOR COMPLETE SET
 KOMPLETT-SET DIVINA GERAHMTE DREHTÜR

BS

FINITURA - FINISHING - OBERFLÄCHE

COMPONENTI - COMPONENTS - EINZELTEILE:

DIV-100

ANTA - PANEL - TÜR

DIV-204 (optional)

LISTELLO - CROSS PROFILE - QUERPROFIL

V-740

SERRATURA COMPATTA ORIZZONTALE
 HORIZONTAL COMPACTED LOCK
 HORIZONTALES KOMPAKTES SCHLOSS

MANIGLIA - HANDLE - GRIFF

TP-300

STIPITE - DOOR JAMB - ZARGE

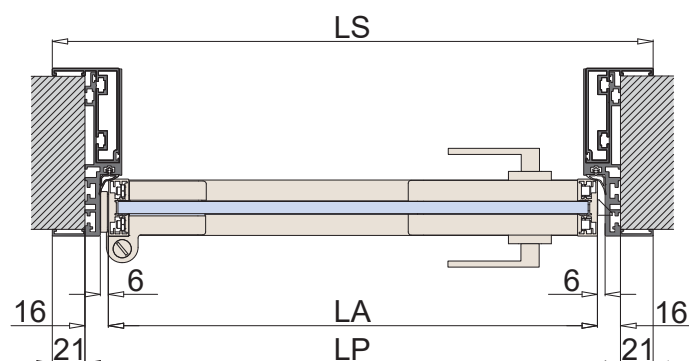

xme636d



DIV-040-740 **PRICE LIST pag. 3** ▶ **DC04**

SET COMPLETO ANTA INTELAIATA DIVINA
 DIVINA FRAMED HINGED DOOR COMPLETE SET
 KOMPLETT-SET DIVINA GERAHMTE DREHTÜR

AN

FINITURA - FINISHING - OBERFLÄCHE

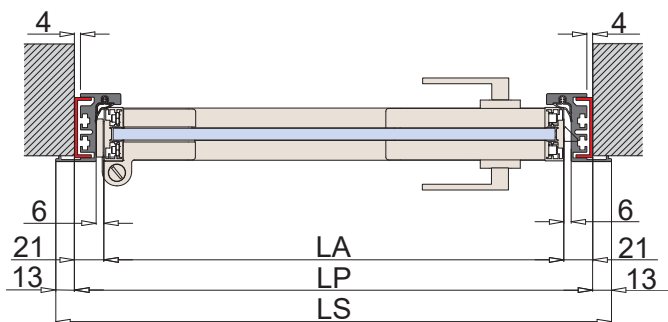

xme636e

COMPONENTI - COMPONENTS - EINZELTEILE:

DIV-100

ANTA - PANEL - TÜR

DIV-204 (optional)

LISTELLO - CROSS PROFILE - QUERPROFIL

V-740

SERRATURA COMPATTA ORIZZONTALE
 HORIZONTAL COMPACTED LOCK
 HORIZONTALES KOMPAKTES SCHLOSS

MANIGLIA - HANDLE - GRIFF

P-040

STIPITE - DOOR JAMB - ZARGE



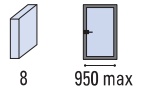

DIV-030

PRICE LIST pag. 2 ► DC01

Pagine tecniche - Technical pages - Technische Seiten ► 40

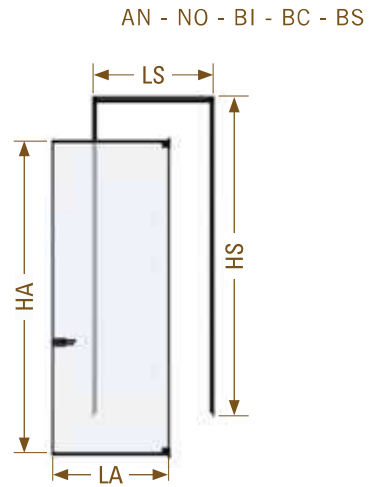
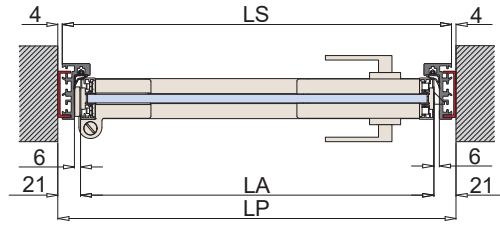
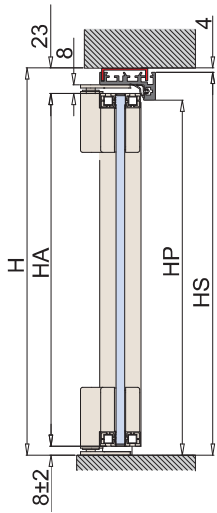

AN - NO - BI - BC - BS

xme636f

DIV-040

PRICE LIST pag. 3 ► DC04

Pagine tecniche - Technical pages - Technische Seiten ► 40

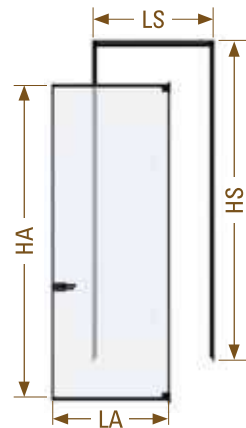
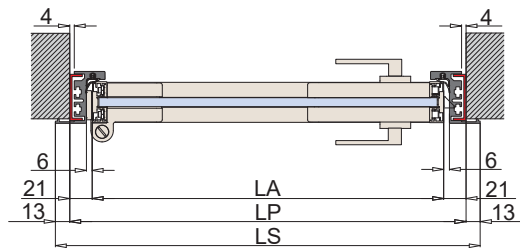
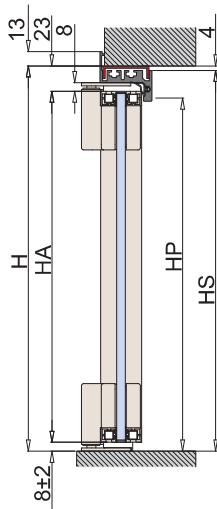

AN - NO

xme636e

DIV-300

PRICE LIST pag. 4 ► DC07

Pagine tecniche - Technical pages - Technische Seiten ► 41

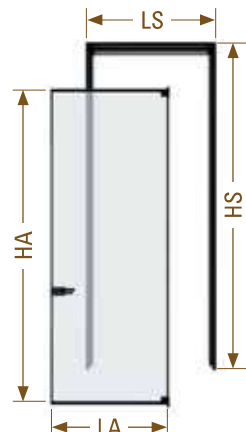
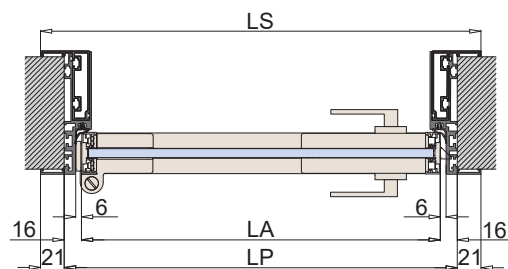
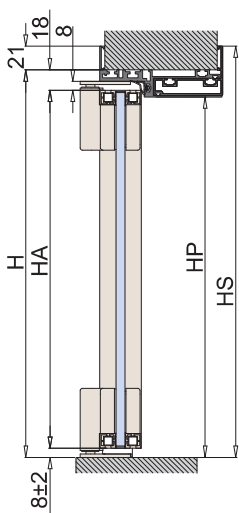

AN - NO - BI - BC - BS

xme636d

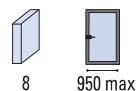

DIV-030 2FLG

PRICE LIST pag. 2 ► DC02

Pagine tecniche - Technical pages - Technische Seiten ► 43

AN - NO - BI - BC - BS

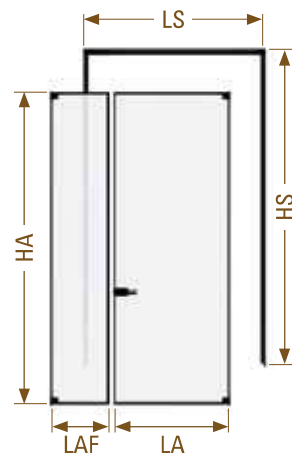
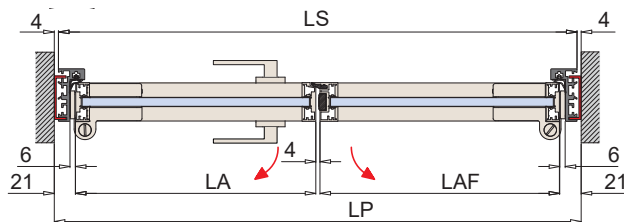
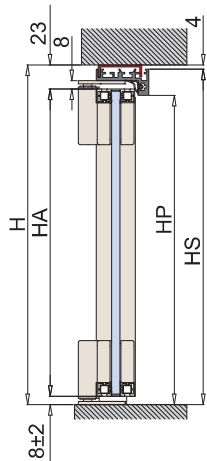

xme636r

DIV-040 2FLG

PRICE LIST pag. 3 ► DC05

Pagine tecniche - Technical pages - Technische Seiten ► 43

AN - NO

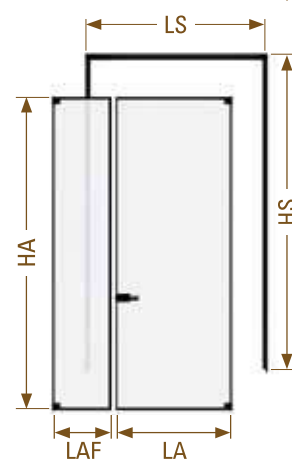
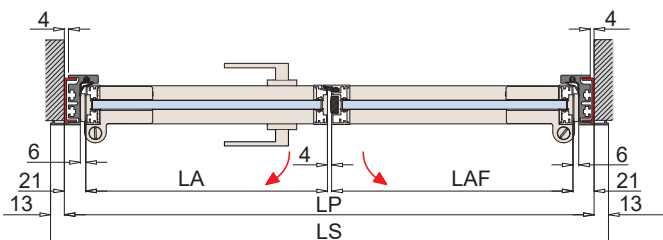
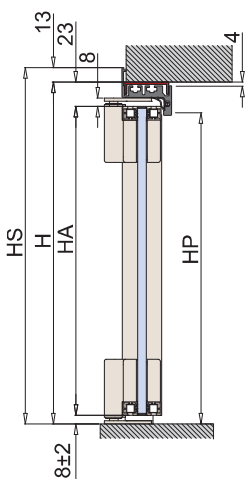

xme636q

DIV-300 2FLG

PRICE LIST pag. 4 ► DC08

Pagine tecniche - Technical pages - Technische Seiten ► 44

AN - NO - BI - BC - BS

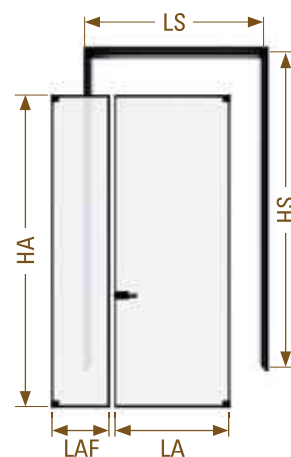
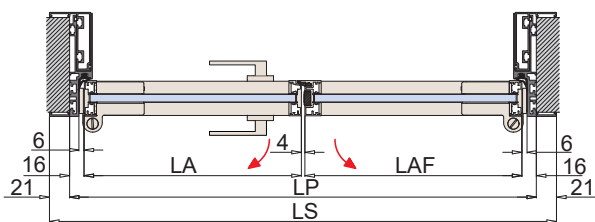
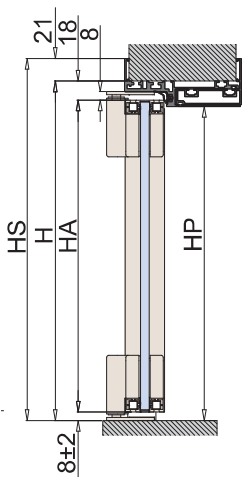

xme636p